



DD  
design  
program

grzejniki  
łazienkowe

# Nowy wymiar ciepła

Serię **DesignProgram** stworzyliśmy z myślą o Klientach dla których grzejniki łazienkowe nie są jedynie praktycznymi urządzeniami technicznymi, ale przede wszystkim stają się równoprawnym elementem aranżacyjnym wystroju wnętrza, nierzadko stając się jego centralnym punktem.

Grzejniki te wyróżnia wysoka estetyka, odpowiedni dobór materiałów i skrupulatna dbałość o jakość wykonania.



**Masz pomysł na swój grzejnik?**

Prześlij nam projekt a pomożemy spełnić Twoje marzenia!

## spis treści

### **DesignProgram**

WIKING	4
NUGAT	4
STONE	5
FRAGIL	6
ESFERA	6
TUBO	7
FUEGO	7
A/P RETRO	8-9
ESTUFA	10
BOLKO	11
WIKI	12
HOJA	13
LOFT	14
ESCALERA	15
ROD	15
ATOM	16
COMB	16
CALLE	17
CAJA	17
TENSOR	18
LUCA	19
WALL	20
MERLIN	21
ITEM	23
VERANO	24
IMPERADOR	25
HOLE	26
ALGO	26
CEDRO	27
ETNA	28
COSTA	29
BORA	30
CARRERA	31
DIAMANTES	32
ALVO	33
MONSUN	34
LEA	35
ZELO	36
REY	37

TORO	37
CLARO	38
MARCO	38
ZORBA	39
MODELO	39
KIDS AUTO	41
KIDS CASA	41
PALO	42
CABRA	42

### **grzejniki chromowane**

A/T/Cr	43
A/U/Cr	43
AD/EL/Cr	44
AD/EP/Cr	44
A/L/Cr	45
A/P/Cr	45

### **wzory na grzejniki**

<b>i szkła</b>	46
<b>rodzaje kamieni</b>	47
<b>grzejniki STANDARD</b>	48-49
<b>grzałki</b>	50
<b>zawory grzejnikowe</b>	
<b>SCHLÖSSER</b>	51



w cenie podstawowy  
zestaw montażowy



możliwość  
podłączenia grzałki



wersja  
z przykręcaną suszarką



grzejnik  
stalowy



grzejnik  
miedziany



grzejnik  
chromowany



grzejnik miedziany  
chromowany



grzejnik  
z podłączeniem dolnym



grzejnik  
z podłączeniem dolnym 50 mm



grzejnik  
z podłączeniem bocznym



grzejnik  
z podłączeniem krzyżowym



5 lat gwarancji na grzejniki  
stalowe i miedziane



dostępny w kolorach  
z palety RAL



występuje jako  
grzejnik elektryczny

kolor, ustojenie  
oryginalność

WIKING zaskakuje ilością suszarek  
łąącząc walory estetyczne  
z użytkowymi

# WIKING

4

H	S	B	Masa	Zabćana moc grzałki	Moc (W) 40/70/200*	70/100/200*
950	500	140	27	300	250	200

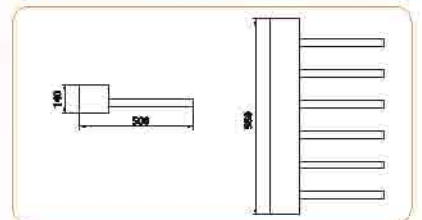

Kamień jest produktem naturalnym i charakteryzuje się niestabilnością zarówno w ubarwieniu jak i ułożeniu, dlatego nie ponosimy odpowiedzialności za zmienność produktu wynikającą z jego natury.



# NUGAT



H	S	B	Masa	Moc (W) 40/70/200*	70/100/200*
350	1000	220	58	400	325

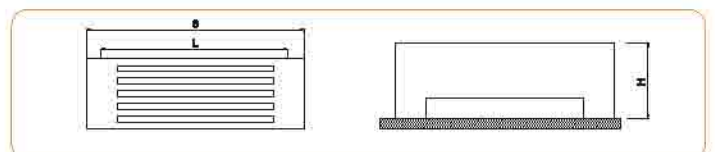





dla miłośników natury,  
nie tylko do łazienki  
STONE to prostota formy  
i duża bryła grzejna  
chromowane uchwyty  
podkreślają piękno  
kamienia

# STONE

5

grzejniki kamienne to  
fascynujący kontrast  
zimnego materiału  
z funkcją grzania

H	B	D	Masa	Zalecana moc grzałki	Moc (W)	
					szafa	ramiona
900	500	200	44	300	375	300
1500	500	200	71	300	500	420

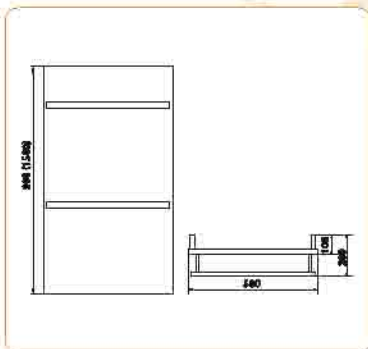

Kamień jest produktem naturalnym i charakteryzuje się niestabilnością zarówno w ubarwieniu jak i użyczeniu, dlatego nie ponosimy odpowiedzialności za zmienność produktu wynikającą z jego natury.



Przykłady wzorów kamieni znajdują się na str. 47.

harmonia,  
rytm,  
symetria

wykreowaliśmy linię  
FRAGIL z myślą  
o użytkownikach  
szukających form  
prostych i praktycznych,  
podkreślających ład  
i uporządkowanie

# FRAGIL

6

# ESFERA



siostrzana ESFERA  
dodatkowo została  
wyposażona w kuliste  
obejmy

FRAGIL	Pow.	H	S	L	Masa	Poj.	Moc (W)	
							200/250*	250/300*
chrom	0,35	850	435	50	6,0	2,2	220	175
kolor RAL	0,35	850	435	50	6,0	2,2	260	210



ESFERA	Pow.	H	S	L	Masa	Poj.	Moc (W)	
							200/250*	250/300*
chrom	0,34	910	560	500	6,5	2,2	220	175
kolor RAL	0,34	910	560	500	6,5	2,2	260	210



FRAGIL

ESFERA

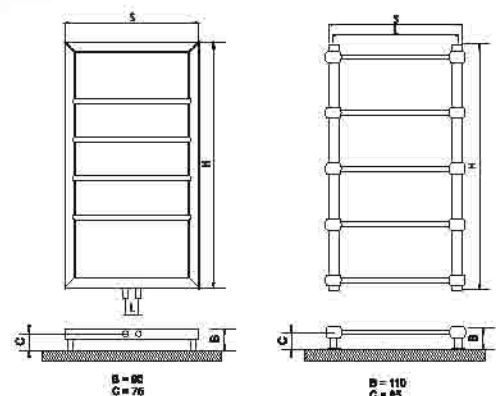



## GRZEJNIKI STALOWE

TUBO podkreśla swoją strzelistość przesunięciem w górę dwóch środkowych rur

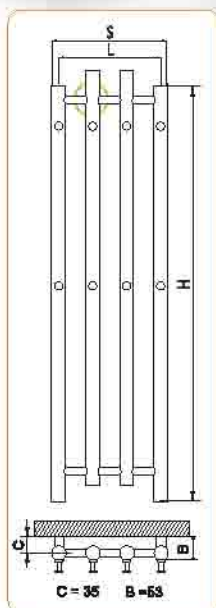

TUBO

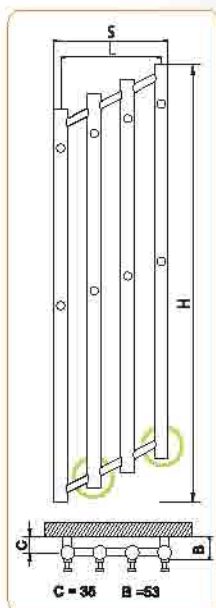

FUEGO

FUEGO zwraca uwagę skośnym układem

smukłe TUBO i FUEGO wypełnią wszystkie wąskie przestrzenie

pozbawione typowych wieszaków nadają się również do innych pomieszczeń takich jak korytarz i przedpokój, gdzie z powodzeniem osuszą mokre ubranie

# TUBO

7

# FUEGO

TUBO	Pow.	H	S	L	Masa	Poj.	Moc (W)	
							19/2020	75/500W
chrom	0,71	1620	290	255	9,2	4,9	390	310
kolor RAL	0,71	1620	290	255	9,2	4,9	490	385

FUEGO	Pow.	H	S	L	Masa	Poj.	Moc (W)	
							19/2020	75/500W
chrom	0,67	1650	290	255	9,0	4,8	380	305
kolor RAL	0,67	1650	290	255	9,0	4,8	480	380



radecó

*Art Deco Design*

dla kochających starocie  
i amatorów klasycznych akcentów

grzejniki RETRO wyróżniają się stylowymi  
pierścieniami i zakończeniami kolektorów  
walorem jest ręczna obróbka patynowania





GRZEJNIKI STALOWE  
 MOSIĄDZOWANE - PATYNOWANE  
 CHROMOWANE  
 KOLORY RAL

Design  
 program



Retro

## A/P RETRO



chrom  
satyna



kolor  
RAL

9

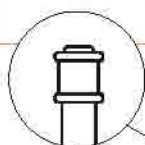

$B = 160 + 170 \text{ mm}$   
 $C = 55 + 65 \text{ mm}$

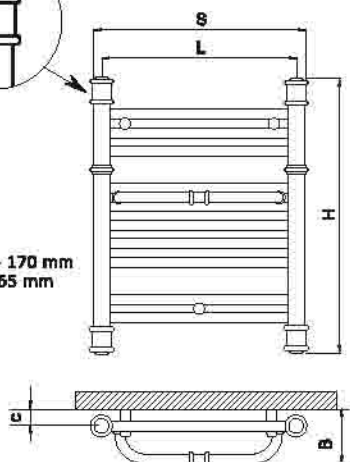

Poz.	H	S	L	Masa	Poj.	Moc (W)		
						15/7/20°C	18/16/20°C	
A1-400/P-retro	0,37	490	435	400	4,4	1,6	220	175
A2-400/P-retro	0,50	680	435	400	5,2	2,2	290	230
A3-400/P-retro	0,62	870	435	400	6,7	3,0	360	290
A4-400/P-retro	0,77	1060	435	400	8,2	3,7	430	345
A5-400/P-retro	0,93	1250	435	400	9,9	4,5	510	410
A6-400/P-retro	1,78	1440	435	400	10,5	5,4	590	470
A1-500/P-retro	0,42	490	535	500	4,9	1,9	240	190
A2-500/P-retro	0,60	680	535	500	5,9	2,6	340	270
A3-500/P-retro	0,75	870	535	500	7,7	3,5	430	345
A4-500/P-retro	0,93	1060	535	500	9,4	4,4	510	405
A5-500/P-retro	1,12	1250	535	500	11,2	5,2	620	495
A6-500/P-retro	1,30	1440	535	500	12,2	5,8	720	580
A1-600/P-retro	0,51	490	635	600	5,5	2,4	265	210
A2-600/P-retro	0,75	680	635	600	7,1	3,3	390	310
A3-600/P-retro	0,94	870	635	600	9,5	4,4	500	400
A4-600/P-retro	1,12	1060	635	600	10,8	5,6	590	470
A5-600/P-retro	1,35	1250	635	600	13,2	6,7	730	590
A6-600/P-retro	1,60	1440	635	600	16,2	7,7	950	760

Dodatki do grzejnika A/P retro na str. 47





radecó



ESTUFA doskonale nadaje się do każdego wnętrza, nie tylko łazienki, przy tym jest w pełni ekologicznym piecem kaflowym

# ESTUFA

wyjątkowy grzejnik nawiązujący do tradycyjnych technik rzemieślniczych

został zbudowany z ręcznie modelowanych kafli ceramicznych.

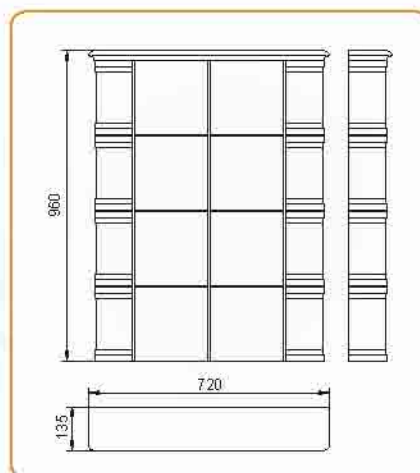

kolor RAL	Pow.	Kolor			Masa	Poj.	Moc (W)	
		960	670	720			bielony	czarny
0,72	0,72	960	670	720	75	4,3	450	410



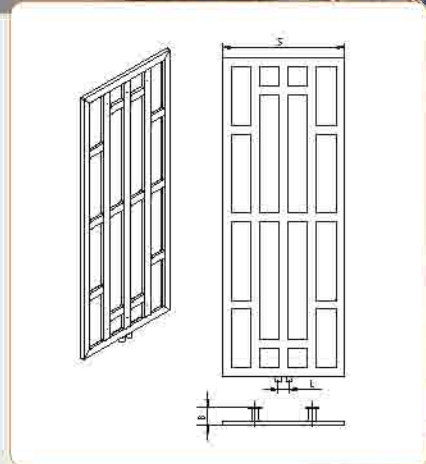
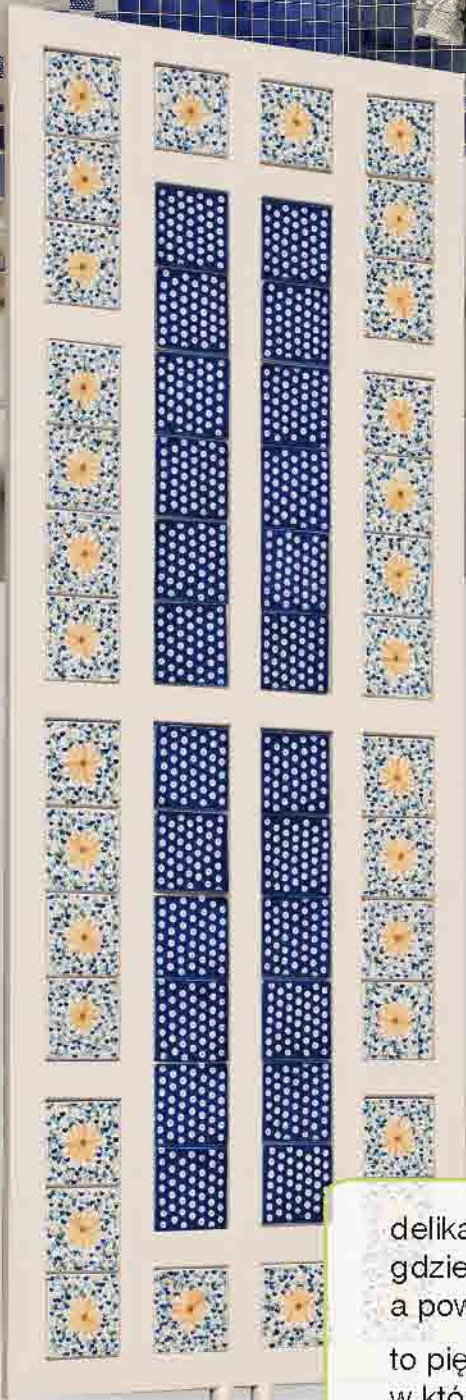

# BOLKO

delikatne muśnięcia pędzla,  
gdzie wzór to sprawa umowna,  
a powtarzalność celem  
to piękno ręcznie malowane,  
w którym nasz grzejnik jest  
jedynie tłem



LUCA	Pow.	H	S	L	Masa	Poj.	Moc (W)	
							wyższej	niższej
kolor RAL	1,58	1700	530	50	26,0	8,3	1160	930





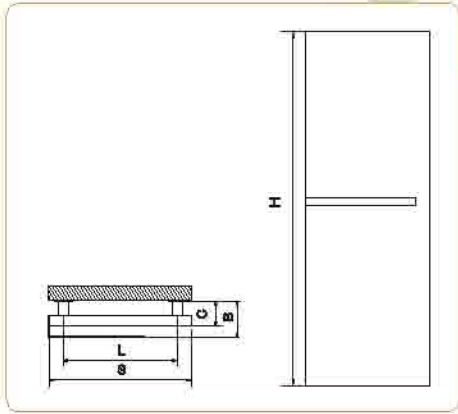

to propozycja dla poszukiwaczy nietypowych rozwiązań w cenie ...subtelny szelest wiklinowych gałązek

# WIKI

12

surowiec naturalny w najczystszej postaci - sumiennie tkana wiklina



Pow.	H	B	C	L	Masa	Poj.	Masa (W)	
		bez wieszaka / wieszaki					90/720	74/620
1,5	1600	590	110/180	500	18	8,3	920	720





# HOJA

13

taki liść ogrzeje  
łazienkę lub  
dziecięcy pokój,  
uwaga:  
nie spada na  
jesień

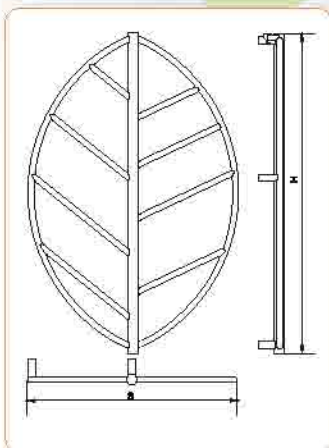

kolor RAL	Pow.	C			Masa	Poj.	Moc (W)	
		1100	750	1050			380	305
0,51	1100	750	1050	7,5	3,4	380	305	



Istnieje możliwość wykonania innych wymiarów pod zamówienie.



# LOFT

14

bardzo wąska  
i stonowana seria  
grzejników do wnętrza  
gdzie linie poziome  
i pionowe dyktują ton  
aranżacji

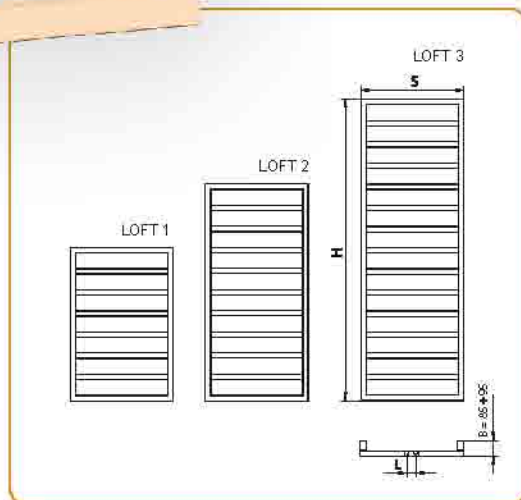
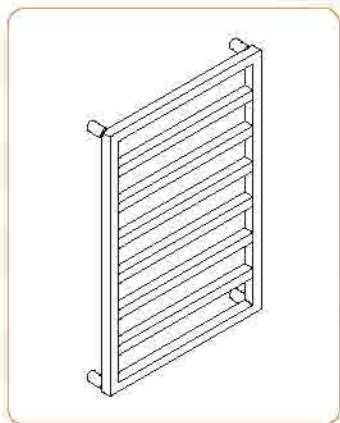

	Pow.	H	D	L	Masa	Poj.	Moc (W)	
							30/40°C	20/25°C
LOFT 1	0,59	821	550	90	7,2	4,1	380	305
LOFT 2	0,81	1160	550	90	10,9	5,6	520	415
LOFT 3	1,08	1612	550	90	13,9	7,7	650	520



bliźniaków niezmiernie trudno rozpoznać  
prezentowane grzejniki różnią się przede wszystkim grubością  
chudszy to ESCALERA (po lewej) a grubszy ROD (po prawej)

# ESCALERA

15

# ROD

ESCALERA 1

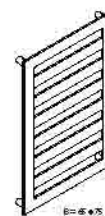

ROD 1

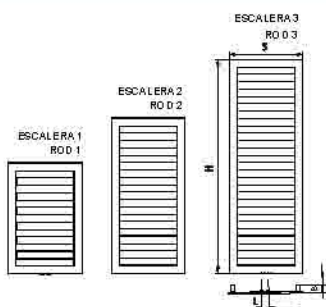
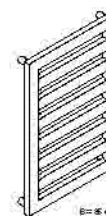

	Pow.	M			Masa	Poj.	Moc (W)	
		H	S	L			90/60/50	70/60/50
ESCALERA 1	0,65	830	550	60	8,7	2,1	425	340
ESCALERA 2	0,89	1160	550	60	11,6	2,8	555	445
ESCALERA 3	1,19	1600	550	60	15,5	3,9	725	580

	Pow.	M			Masa	Poj.	Moc (W)	
		H	S	L			90/60/50	70/60/50
ROD 1	0,84	830	550	90	14,5	7,6	440	430
ROD 2	1,16	1160	550	90	19,3	10,3	725	580
ROD 3	1,58	1600	550	90	25,1	13,5	960	770

ATOM

nie można przejść obok nich obojętnie przyciągają uwagę oryginalnością formy i kształtu

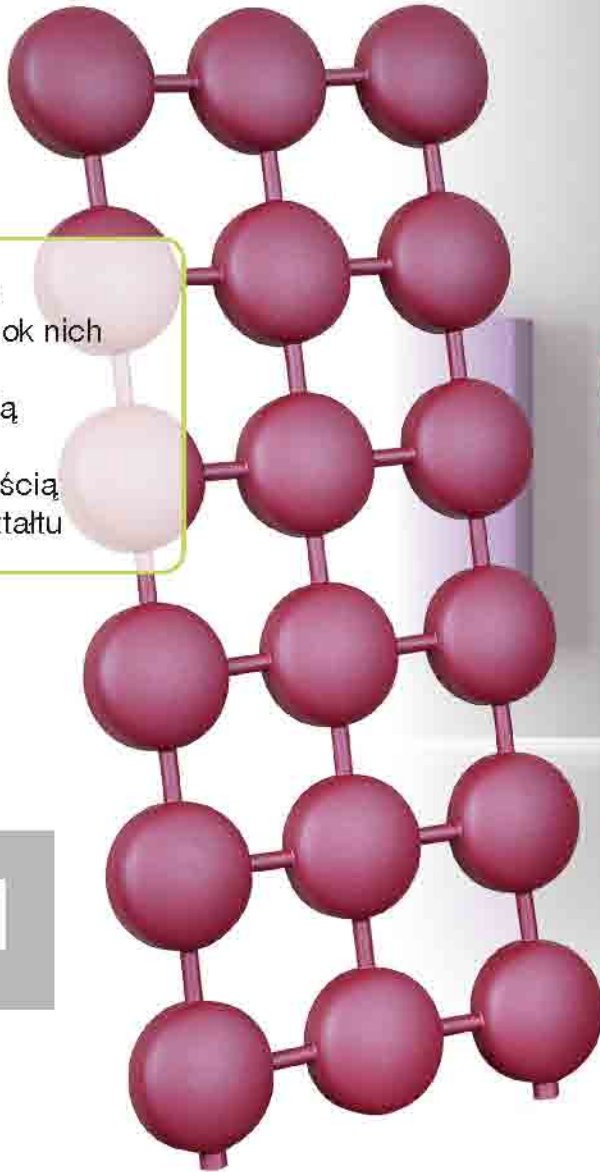

COMB

# ATOM

16

# COMB

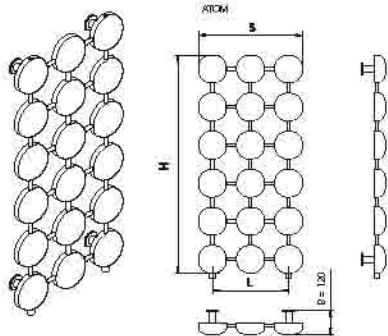

	Pow.	H	S	L	Masa	Poł.	Moc (W)	
							przew.	rozpr.
ATOM	0,93	520	1100	120	26,5	11,2	590	470

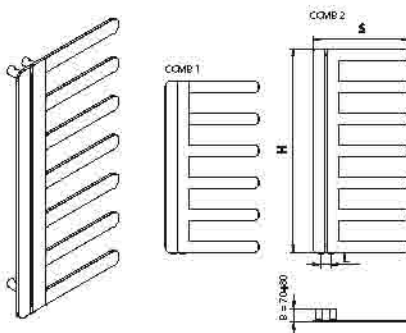

	Pow.	H	S	L	Masa	Poł.	Moc (W)	
							przew.	rozpr.
COMB 1	0,49	860	480	90	6,8	1,4	390	310
COMB 2	0,57	1020	480	90	7,7	1,8	450	360



CALLE

wąskie,  
smukłe,  
idealne do  
aranżacji  
pozbawionych  
wielkich  
płaszczyzn

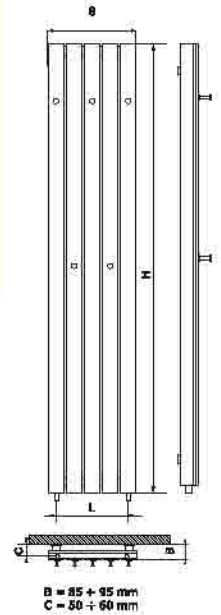

CALLE

17

CAJA

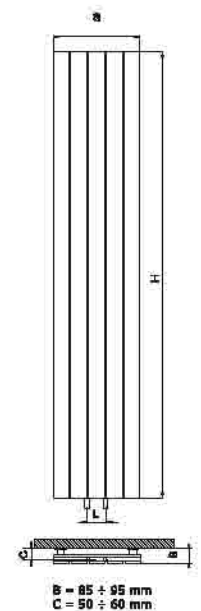

GRZEJNIKI STALOWE

CALLE	Pow.	H	S	L	Masa	Poj.	Moc (W)	
							grzewcza	regulacja
CALLE 1	0,95	1650	340	50	14,0	2,8	690	550
CALLE 2	1,71	1650	620	50	25,2	5,1	1190	950
CALLE 3	0,67	1200	340	50	11,9	2,1	495	395
CALLE 4	1,19	1200	620	50	20,9	3,7	860	690



CAJA	Pow.	H	S	L	Masa	Poj.	Moc (W)	
							grzewcza	regulacja
CAJA 1	1,49	1650	320	50	21,0	3,5	1050	860
CAJA 2	2,92	1650	645	50	42,0	7,1	2010	1610
CAJA 3	1,08	1200	320	50	16,0	2,5	780	620
CAJA 4	2,11	1200	645	50	32,0	5,1	1470	1180



CAJA



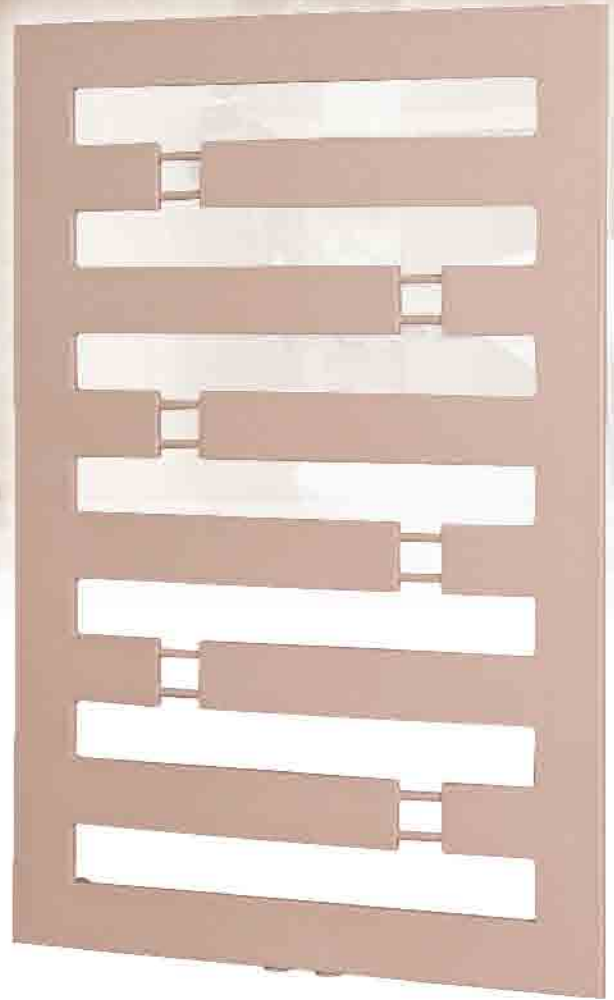
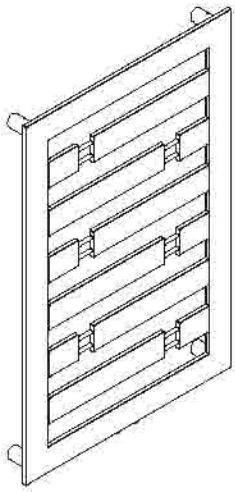

# TENSOR

18

kolejna propozycja płaskich grzejników  
wyśmienity wygląd zawdzięczają również  
pomalowaniem farbami strukturalnymi

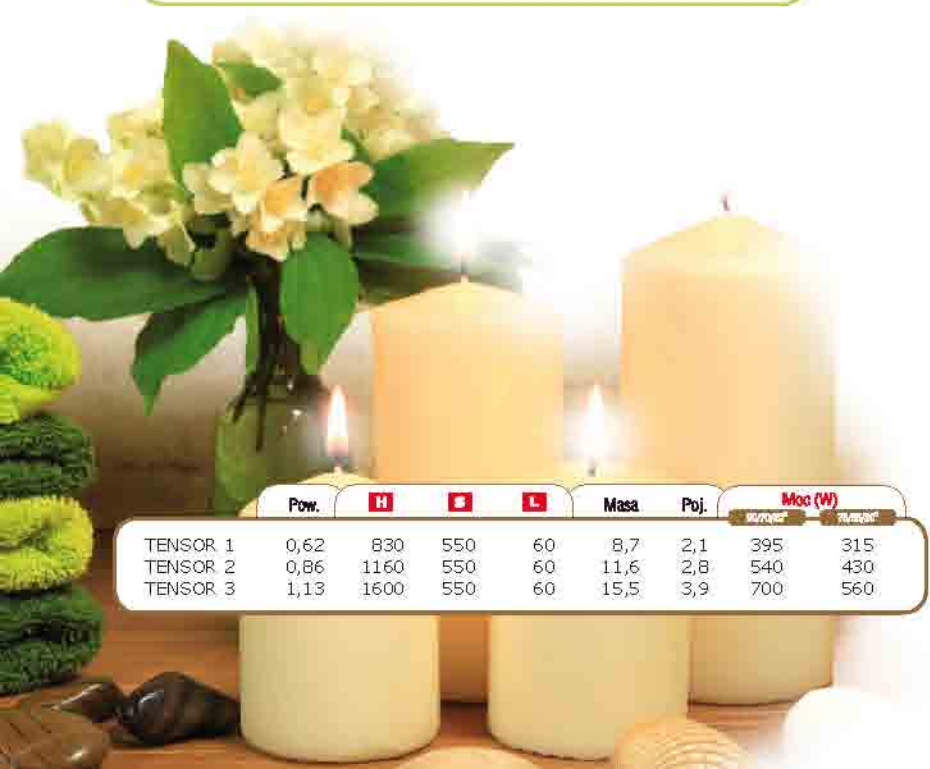

	Pow.	H	S	L	Masa	Poj.	Moc (W)	
							średnia	maksymalna
TENSOR 1	0,62	830	550	60	8,7	2,1	395	315
TENSOR 2	0,86	1160	550	60	11,6	2,8	540	430
TENSOR 3	1,13	1600	550	60	15,5	3,9	700	560

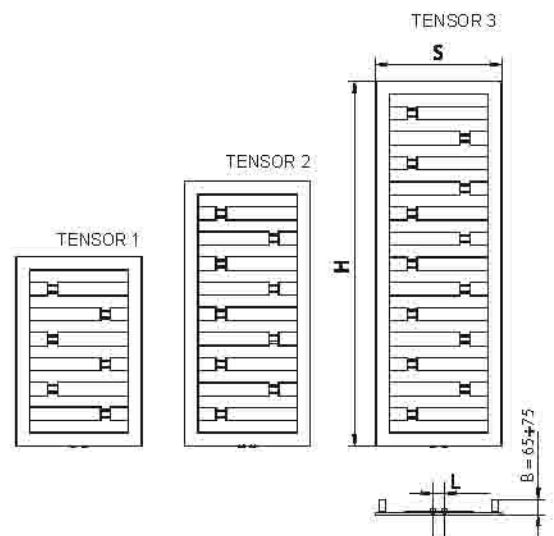



# LUCA

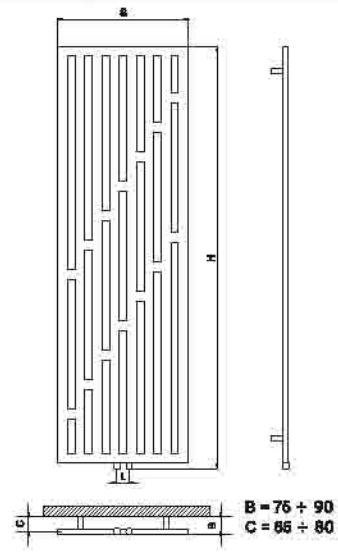

grzejnik łazienkowy składa się z okrągłych rur ... LUCA sprzeciwił się tej zasadzie



LUCA	Pow.	H	B	L	Masa	Foj.	Moc (W)	
							wyższej	niższej
kolor RAL	1,58	1700	530	50	26,0	8,3	1160	930





wzornictwo do minimum?  
WALL dowodzi, że  
jak najbardziej tak

# WALL

20

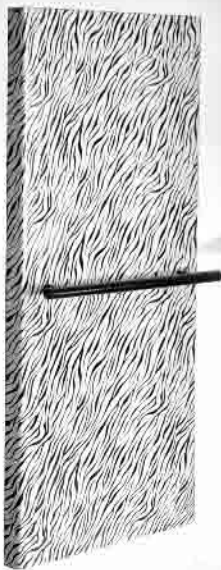

linia dla kreatywnych  
gdzie grzejnik może  
stać się obrazem

Oferujemy grzejnik z  
nadrukiem fotografii lub grafiki  
zaprojektowanej przez klienta

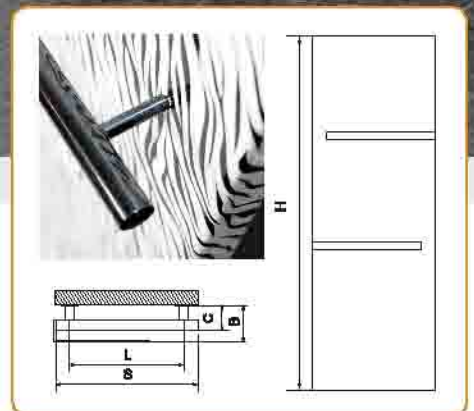

Uchwyty także dostępne w kolorach RAL

Pow.	H	S	G	L	Masa	Poj.	Zakończona moc grzałki	Moc (W)	
								90/300°	70/60/57
1,5	1600	560	110/180	500	27	8,3	600	1020	820



diamenty  
najlepszym  
przyjacielem  
kobiety

MERLIN

21

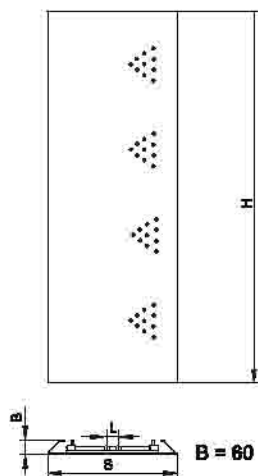

grzejnik  
inkrutowany  
kryształkami,  
dostępny  
w pełnej gamie  
kolorów



Istnieje możliwość wyboru wzoru, motywu na grzejniku przez klienta.



kolor RAL	Pow.	H	S	L	Masa	Poj.	Moc (W)	
							grzejnik	rurociąg
1,2	1600	560	50	34	6,1	1040	830	







02993 (460)



02985



02980



02992



02996

# ITEM

... grzejnik ...  
... kolor...  
... wieszaki ...  
a rozmieszczenie?  
... wedle uznania!



02966 (460)



02957



02952



02965



02969



ITEM bez stresów...

Klient samodzielnie dobiera wyposażenie grzejnika  
oraz ich ustala rozmieszczenie



23

Pow.	[H] [S] [D] [L] <small>(bez wleczaka)</small>				Masa	Poj.	Zakładana moc grzałki	Moc (W)	
	1,5	1600	560	110				500	27
							900	1020	820



Uchwyty także dostępne w kolorach RAL.

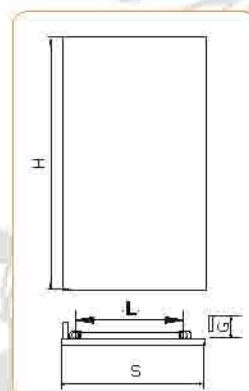

Powyzsze ilustracje prezentują przykładowe zestawy.



klasyczne ażurowe motywy dodadzą ciepła w każdym wnętrzu

# VERANO

24



Istnieje możliwość wyboru wzoru motywu na grzejniku przez klienta.



Oferujemy grzejnik z nadrukiem fotografii lub grafiki zaprojektowanej przez klienta

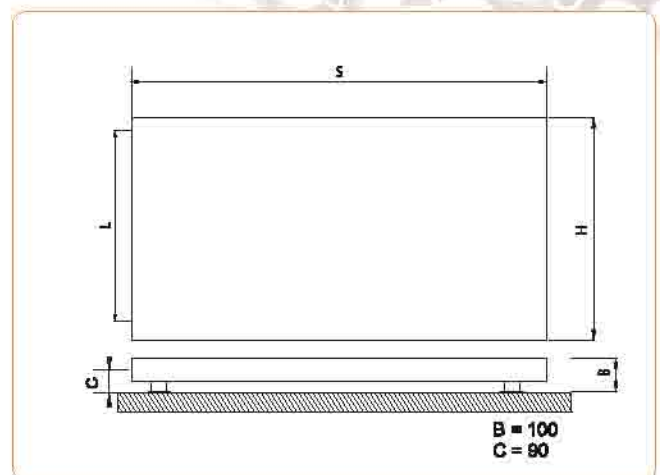

Pow.	H	D	L	Masa	Poj.	Moc (W)		
						szczyt	normal	
kolor RAL	0,95	600	1100	500	36,0	4,3	730	585



# GRZEJNIKI STALOWE

Design program



## IMPERADOR

surowej sylwetce wyrazu nadają farby strukturalne

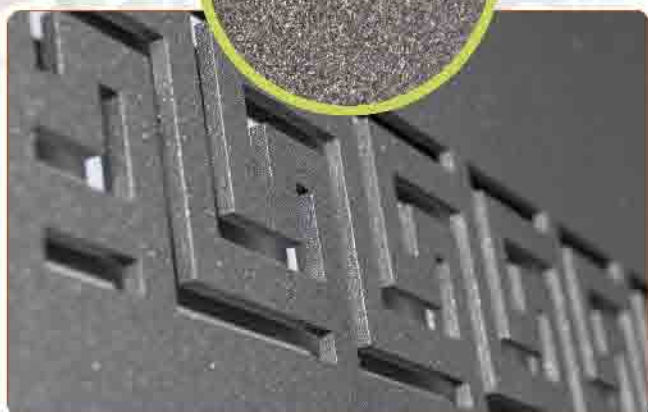

Istnieje możliwość wyboru wzoru, motywu na grzejniku przez klienta.



Pow.	[zak. włącznik w kształcie]				Masa	Poj.	Zakładana moc grzałki	Moc (W)	
	H	D	E	L				standard	max
1,5	1600	560	110/180	500	27	8,3	600	1020	820





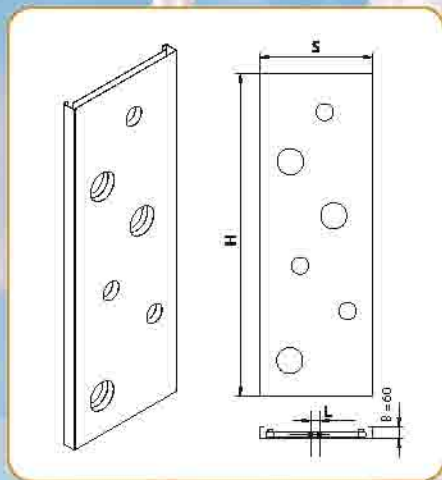

kolor RAL	Pow.	H	B	L	Masa	Poj.	Zakazana moc grzałki	Moc (W)	
								W1ACR	T1ACR
	1,06	1600	560	50	39,0	5,2	600	610	490



# HOLE

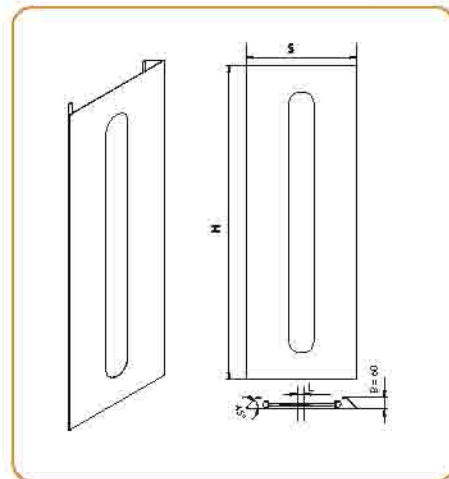

kolor RAL	Pow.	H	B	L	Masa	Poj.	Zakazana moc grzałki	Moc (W)	
								W1ACR	T1ACR
	0,95	1600	560	50	38,0	3,8	300	590	475

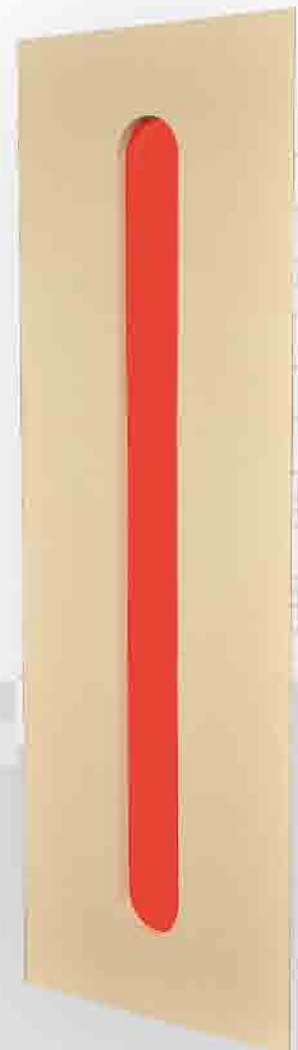

# Design program

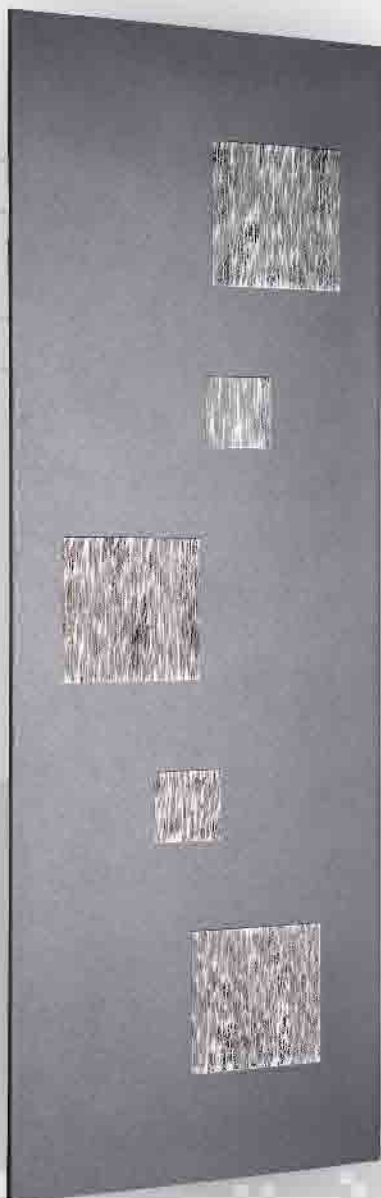
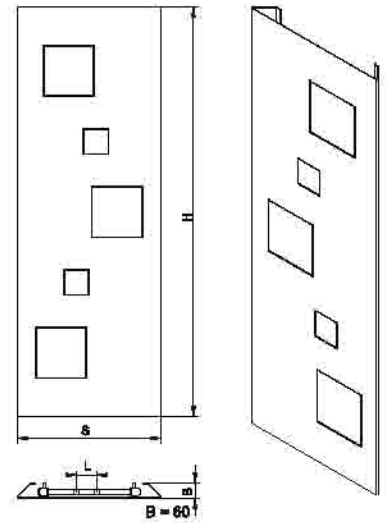

Uchwyty także dostępne w kolorach RAL.

## CEDRO

27

oszczędna  
forma CEDRO  
uszlachetniona  
atrakcyjnymi  
wstawkami  
ze szkła  
artystycznego

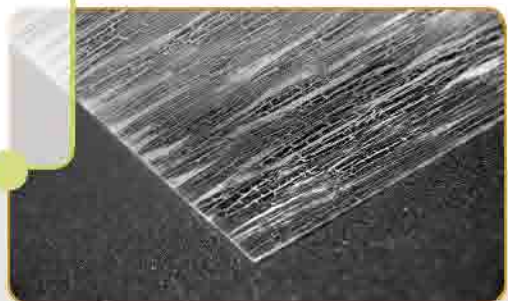

CEDRO:

	Pow.	H	S	L	Masa	Poj.	Zabana moc grzałki	Moc (W)	
								termo	elektr
kolor RAL	1,2	1600	560	50	34	6,1	900	1040	830





wykończenie:  
metalizowana  
farba brokatowa

tafla szklana  
grawerowana  
od wewnątrz

# ETNA

28

istnieje możliwość  
naniesienia dowolnej  
fotografii lub grafiki  
na szkło

	Pow.	H	S	L	Masa	Poj.	Zalecana moc grzałki	Moc (W)	
								standard	termost.
kolor RAL	1,2	1600	560	50	34	6,1	900	1040	830

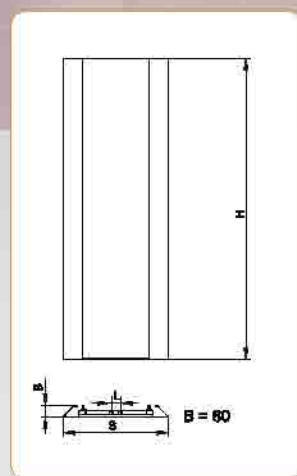



COSTA  
fascynujący grzejnik ze  
szklanym frontem,  
nieopisane efekty wizualne  
mieniącego się szkła,  
alternatywa dla metalowych  
grzejników

tafla bezpiecznego szkła  
pokryta specjalną farbą

# COSTA

29

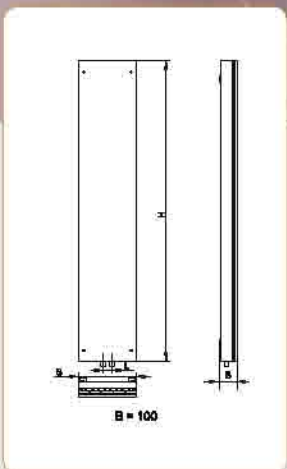

kolor RAL	Pow.	H	C	L	Masa	Poj.	Moc (W)	
							bezwyk.	standard
COSTA 1	1,49	1650	320	50	36	3,5	1050	860
COSTA 2	3,99	1650	645	50	72	7,1	2050	1610





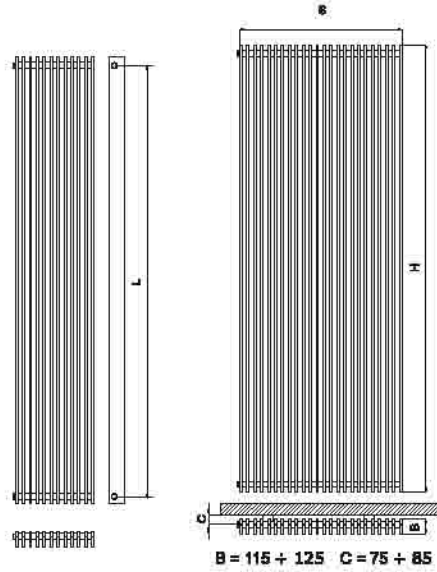

# BORA

BORA w klasyczny sposób nawiązuje do grzejników żeberkowych, dlatego swoje miejsce może znaleźć nie tylko w łazience

	Pow.	H	D	L	Masa	Poj.	Moc (W)	
							konwert	radecor
BORA 1	2,76	1800	330	1740	36,0	8,4	2010	1610
BORA 2	5,51	1800	670	1740	72,0	20,3	3820	3060
BORA 3	1,83	1200	330	1140	24,0	5,7	1350	1080
BORA 4	3,67	1200	670	1140	48,0	10,8	2570	2060
BORA 5	0,92	600	330	540	12,0	2,9	760	610
BORA 6	1,84	600	670	540	24,0	5,6	1440	1150



dwa w jednym,  
CARRERA występuje  
jako grzejnik narożnikowy  
lub płaski



# CARRERA

31

CARRERA N

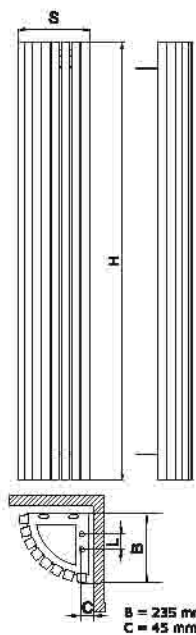

CARRERA P

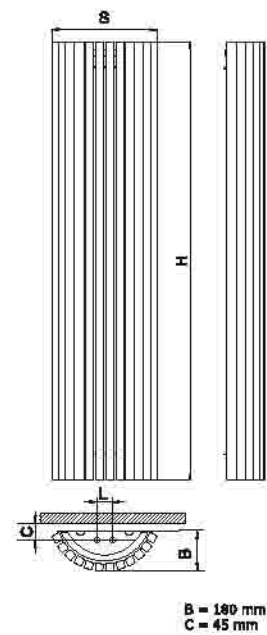

	Pow.	H		L	Masa	Poj.	Moc (W)	
		1800	235				1170	1380
CARRERA N	1,60	1800	235	50	23,0	6,8	1170	940
CARRERA P	2,40	1800	430	50	33,0	10,3	1730	1380







# DIAMANTES

32

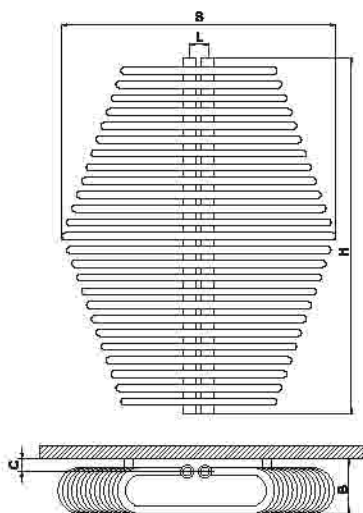

B = 180 + 190 mm  
C = 55 + 65 mm

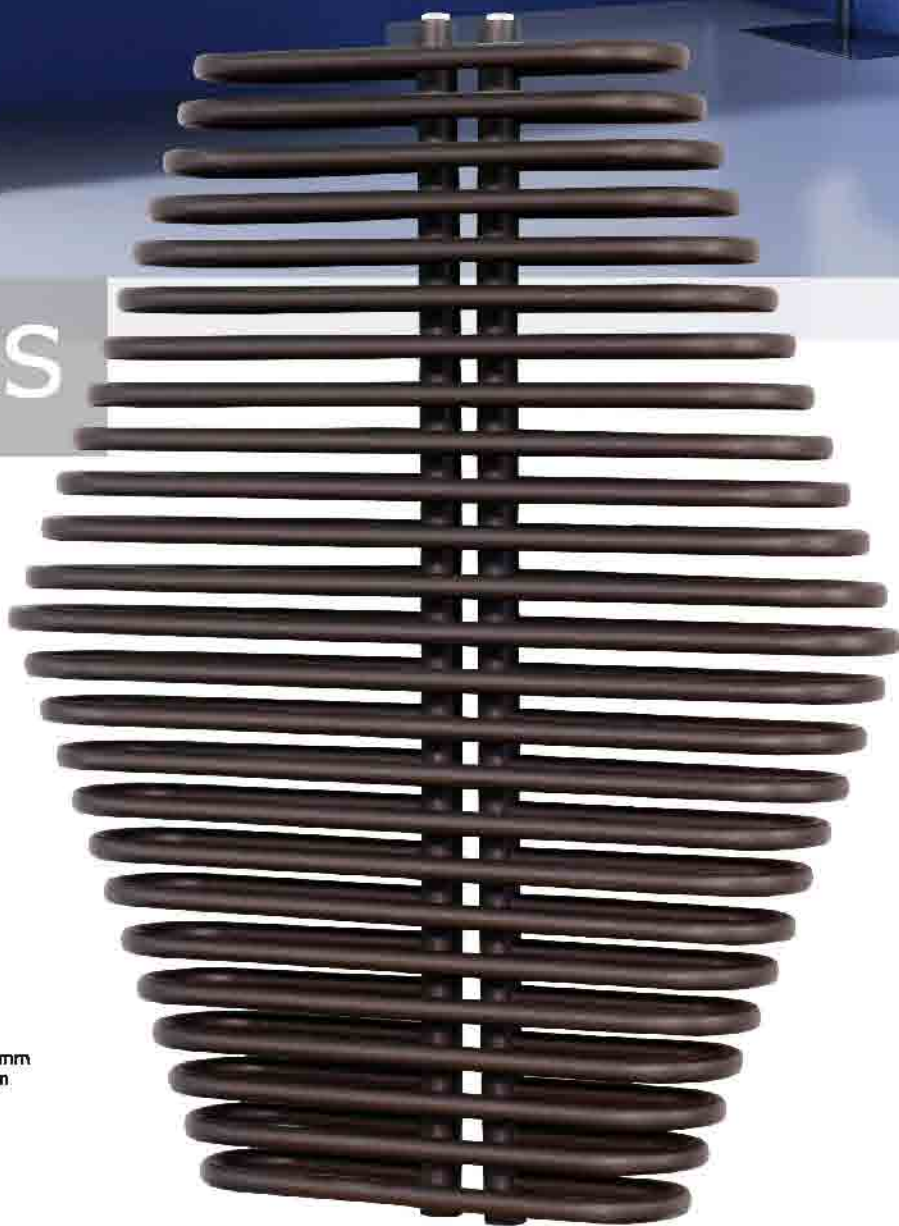

DIAMANTES	Pow.	H			Masa	Poj.	Moc (W)	
		9	5	L			sztywny	zmienny
kolor RAL	1,36	990	700	50	14,0	9,3	990	790



## GRZEJNIKI STALOWE

Design  
program

ALVO wizualnie poszerzy wnętrze, polecany wszędzie tam, gdzie nie ma miejsca na tradycyjny pionowy grzejnik łazienkowy



# ALVO

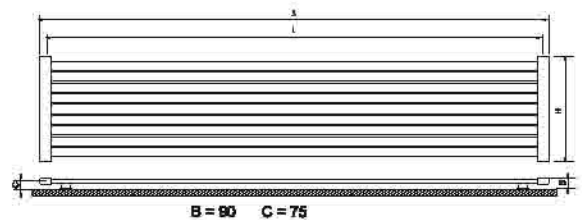
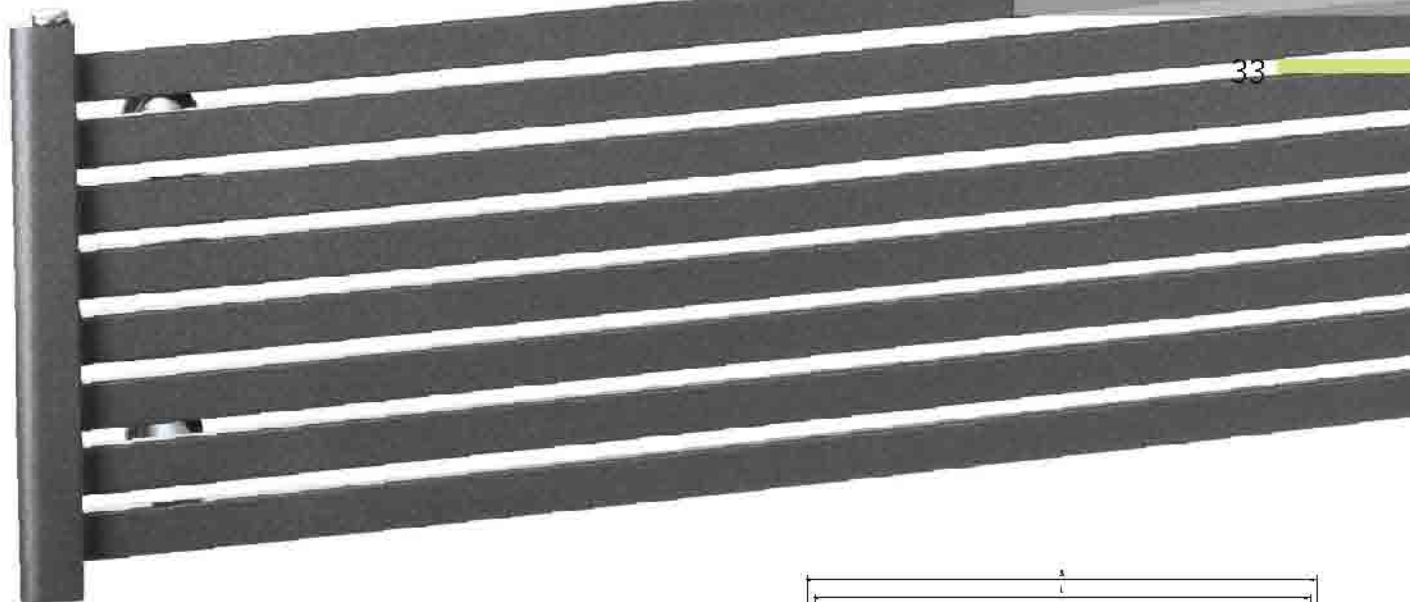

ALVO

	Pow.	H	B	L	Masa	Poj.	Moc (W)	
							w/m <sup>2</sup>	realizacji
ALVO 1	0,71	350	1000	950	7,0	1,9	540	430
ALVO 2	1,35	630	1000	950	13,1	3,5	950	760
ALVO 3	0,88	350	1300	1250	9,0	2,3	660	530
ALVO 4	1,65	630	1300	1250	16,8	4,3	1170	935
ALVO 3	1,05	350	1600	1550	11,0	2,7	790	630
ALVO 4	1,96	630	1600	1550	20,6	5,1	1390	1110







# MONSUN

34

MONSUN to kolejny grzejnik łączący walory estetyczne i praktyczne, dlatego wyposażyliśmy go w dodatkową półkę.

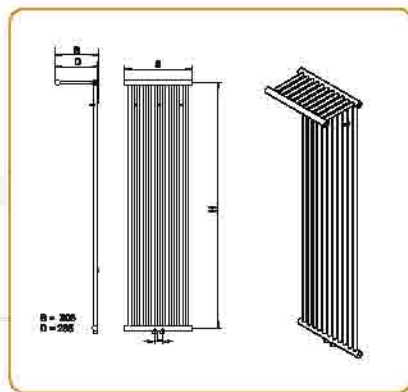
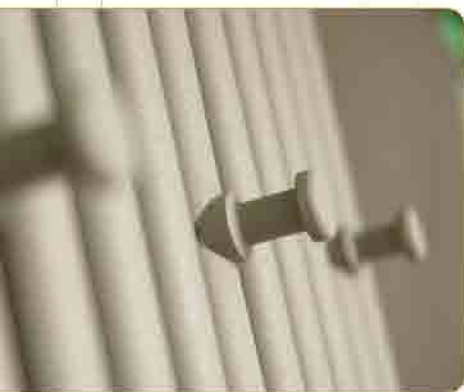

MONSUN doskonale sprawdza się w mokre dni, a nasze dzieci nie będą miały mokrej czapki...

MONSUN

Pow.

H

D

L

Masa

Poj.

Moc (W)

90/70/20° 70/60/20°

kolor RAL	1,42	1685	450	50	11,5	6,0	850	680
-----------	------	------	-----	----	------	-----	-----	-----



LEA o klasycznym układzie posiada dużą powierzchnię do umieszczenia dowolnie wybranego wzoru



LEA

35

radeco

... a może rozwiązanie komercyjne?

podkreśli prestiż każdej firmy, hotelu, baru ...

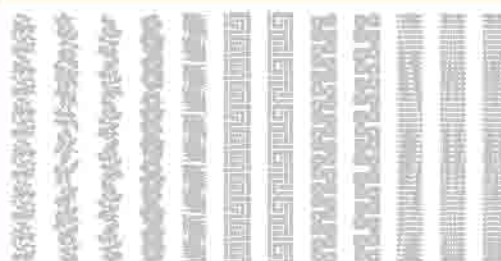
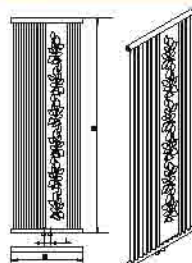

	Pow.	H			L	Masa	Poj.	Moc (W)	
		1	2	3				55/70/27°	70/85/20°
kolor RAL	1,54	1685	565	50	16	4,8	680	540	
chrom	1,54	1685	565	50	16	4,8	530	425	





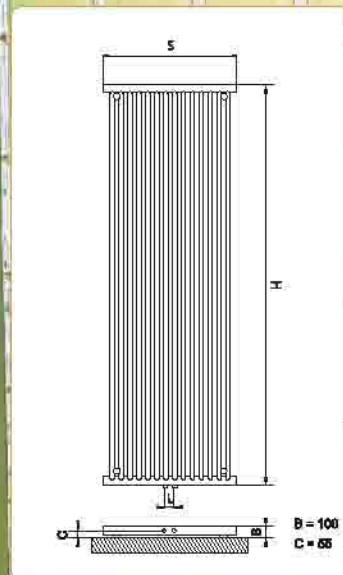

Pow.	[Icons]			Masa	Poj.	Moc (W)	
	1685	565	50			grzejnik	radiacja
chrom	1,54	1685	565	14,5	6,3	870	590
kolor RAL	1,54	1685	565	14,5	6,3	1090	870



# ZELO

36



chromowanie to sprawdzony sposób uszlachetnienia grzejników, nadaje blasku i lekkości każdej łazience

**GRZEJNIKI STALOWE**

lustro pełni dwie funkcje,  
estetyczną i praktyczną

REY	Pow.	H	S	L	Masa	Poj.	Moc (W)	
							90/120°	70/90°
chrom	0,67	1685	565	50	16,0	4,8	530	425
kolor RAL	0,67	1685	565	50	16,0	4,8	680	540

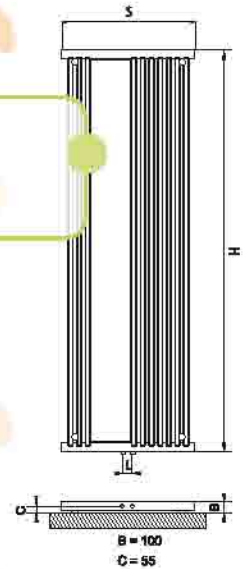

REY

37

TORO

TORO	Pow.	H	S	L	Masa	Poj.	Moc (W)	
							90/120°	70/90°
kolor RAL	1,56	1860	610	50	14,0	8,3	940	750

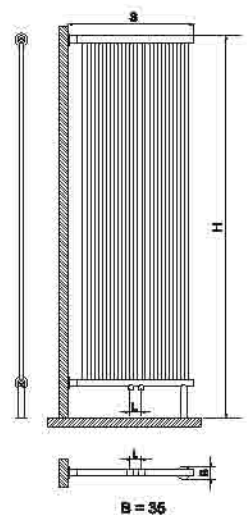

grzejnik czy ...  
dyskretny parawan?

to pomysł na podział  
przestrzeni bez utraty  
cennego miejsca

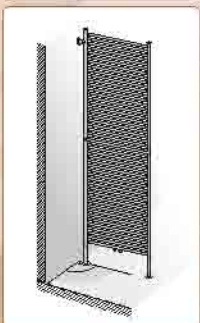



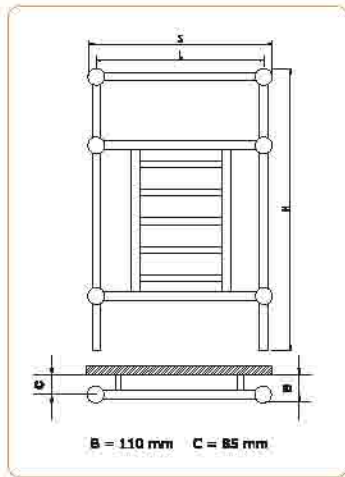

# CLARO

	Pow.	H	S	L	Masa	Poj.	Moc (W)	
							średnica	nominal
chrom	0,42	860	550	500	7,5	2,2	270	215
biały	0,42	860	550	500	7,5	2,2	320	255



38

# MARCO

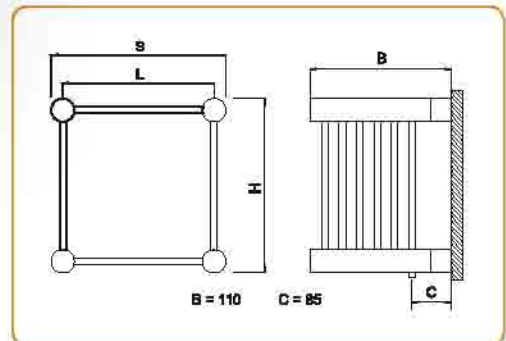

	Pow.	H	S	L	Masa	Poj.	Moc (W)	
							średnica	nominal
kolor RAL	0,56	435	435	400	6,0	2,5	320	255



design program

ZORBA to podwójny klasyk, połączenie idealnie wyważonej formy klasycznego grzejnika z inspirowanym antykiem ażurowym motywem

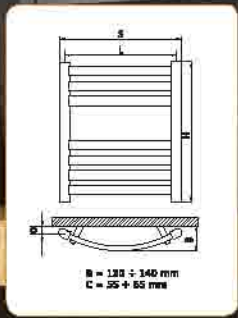

Istnieje możliwość wykonania grzejników o innych wymiarach i wzorach

Pow.	[H] [S] [C] [L] <small>(bez wskazal z wskazaniem)</small>				Masa	Poj.	Zaklana moc grzałki	Moc (W)	
	kolor RAL	0,71	845	550				500	8,4

# ZORBA



# MODELO

JAKO WYPOSAŻENIE  
DODATKOWE O FERUJEJ  
PRZYJMUJĄCĄ SZEROKOŚĆ  
TYPU WL

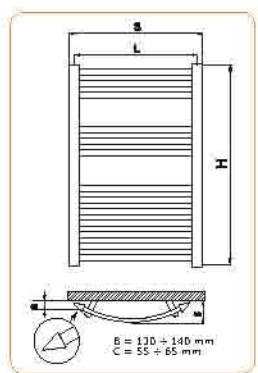

Pow.	[H] [S] [C] [L] <small>(bez wskazal z wskazaniem)</small>				Masa	Poj.	Zaklana moc grzałki	Moc (W)	
	kolor RAL	0,63	680	576				140	5,7



Istnieje możliwość wykonania grzejników o innych wymiarach i wzorach



# Kids

linia *radeco kids* została stworzona z myślą o naszych milusińskich, nadaje pomieszczeniu oryginalny wygląd.

40



istnieje możliwość naniesienia dowolnego rysunku lub zdjęcia



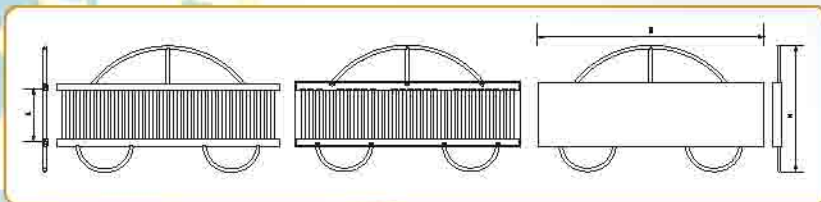

AUTO	Pow.	H	D	L	Masa	Poj.	Moc (W)	
							silnik	rozmiar
kolor RAL	0,45	680	1250	300	15	3,2	560	450

# AUTO



41

# CASA

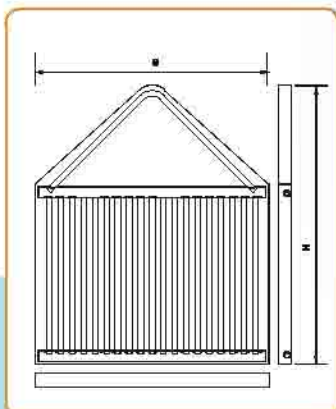

CASA	Pow.	H	D	L	Masa	Poj.	Moc (W)	
							silnik	rozmiar
kolor RAL	0,9	1030	900	50	15	4,3	630	505



Istnieje możliwość wykonania innych wymiarów pod zamówienie



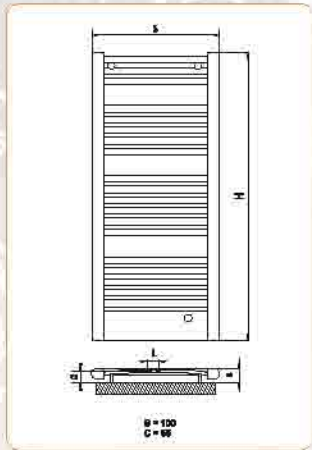

RAL	Pow.	H	B	L	Masa	Poj.	Moc (W)	
							90/100°C	75/85°C
RAL	1,02	1240	550	500	12,7	4,2	760	610



# PALO

42

# CABRA

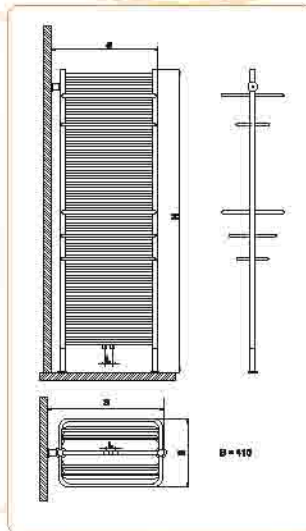
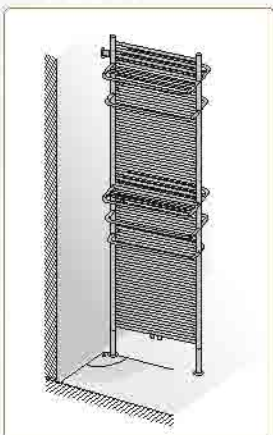

kolor RAL	Pow.	H	B	L	Masa	Poj.	Moc (W)	
							90/100°C	75/85°C
kolor RAL	2,51	2000	700	50	23,0	9,4	1750	1400



# GRZEJNIKI STALOWE CHROMOWANE

Design  
program

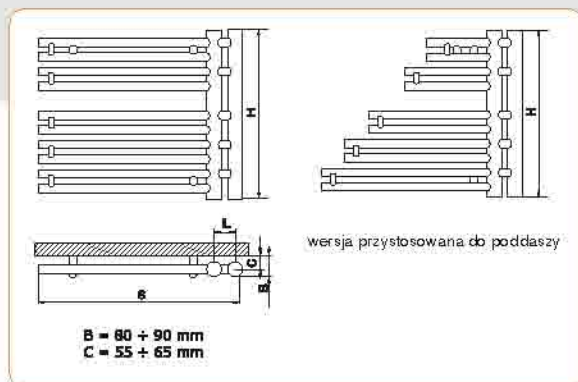
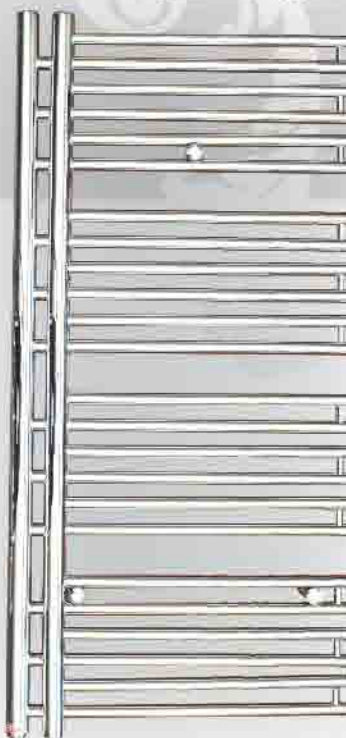

	Pow.	H	C	L	Masa	Poj.	Moc (W)	
							max	min
A1/T/Cr	0,47	450	500	50	4,5	2,1	220	175
A2/T/Cr	0,64	680	500	50	6,4	3,0	300	240
A3/T/Cr	0,81	870	500	50	8,1	3,8	370	290
A4/T/Cr	1,00	1060	500	50	9,9	4,7	460	390
A5/T/Cr	1,20	1210	500	50	11,8	5,7	550	470
A6/T/Cr	1,36	1400	500	50	13,7	6,0	610	490

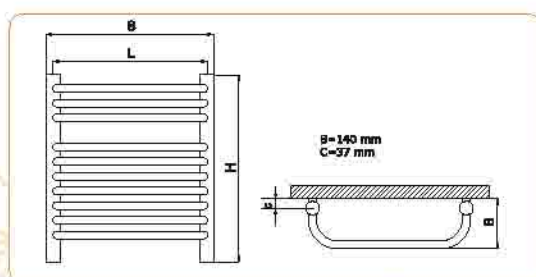

	Pow.	H	C	L	Masa	Poj.	Moc (W)	
							max	min
A1-400/U/Cr	0,45	490	435	400	4,2	2,0	240	190
A2-400/U/Cr	0,65	680	435	400	5,4	2,7	330	260
A3-400/U/Cr	0,82	870	435	400	7,2	3,6	420	335
A4-400/U/Cr	1,02	1060	435	400	8,9	4,5	505	405
A5-400/U/Cr	1,22	1250	435	400	10,8	5,4	610	485
A6-400/U/Cr	1,42	1440	435	400	12,6	6,3	710	565
A1-500/U/Cr	0,52	490	535	500	4,9	2,3	280	225
A2-500/U/Cr	0,75	680	535	500	6,2	3,2	385	310
A3-500/U/Cr	0,95	870	535	500	8,3	4,2	490	390
A4-500/U/Cr	1,18	1060	535	500	10,3	5,2	595	475
A5-500/U/Cr	1,41	1250	535	500	12,4	6,3	720	575
A6-500/U/Cr	1,64	1440	535	500	14,5	7,3	840	670
A1-600/U/Cr	0,59	490	635	600	5,5	2,6	315	250
A2-600/U/Cr	0,85	680	635	600	7,1	3,6	435	345
A3-600/U/Cr	1,07	870	635	600	9,4	4,6	550	440
A4-600/U/Cr	1,33	1060	635	600	11,8	5,8	670	540
A5-600/U/Cr	1,59	1250	635	600	14,1	7,0	810	650
A6-600/U/Cr	1,86	1440	635	600	16,4	8,1	950	760



A/T/Cr

43

A/U/Cr





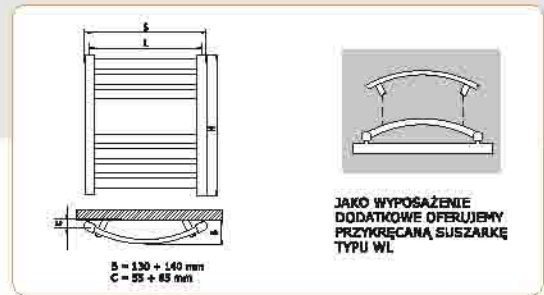

	Pow.	H	S	L	Masa	Poj.	Moc (W)	
							WYKORCZ	TAJASZCZ
AD1-500/EL/Cr	0,33	415	550	500	4,1	1,1	140	115
AD2-500/EL/Cr	0,58	715	550	500	7,6	2,4	240	190
AD3-500/EL/Cr	0,71	850	550	500	8,4	2,9	290	230
AD4-500/EL/Cr	0,86	1060	550	500	11,2	3,4	340	270
AD5-500/EL/Cr	1,03	1240	550	500	12,7	4,2	415	330
AD6-500/EL/Cr	1,19	1450	550	500	14,1	4,9	475	380
AD7-500/EL/Cr	1,37	1630	550	500	16,3	5,6	530	425
AD1-600/EL/Cr	0,38	415	650	600	4,7	1,7	180	145
AD2-600/EL/Cr	0,66	715	650	600	8,6	3,5	290	235
AD3-600/EL/Cr	0,81	850	650	600	9,6	4,2	355	285
AD4-600/EL/Cr	0,98	1060	650	600	12,6	5,0	420	335
AD5-600/EL/Cr	1,18	1240	650	600	14,5	6,0	500	400
AD6-600/EL/Cr	1,36	1450	650	600	16,1	7,1	570	455
AD7-600/EL/Cr	1,57	1630	650	600	18,6	8,1	650	525



AD/EL/Cr

44

AD/EP/Cr

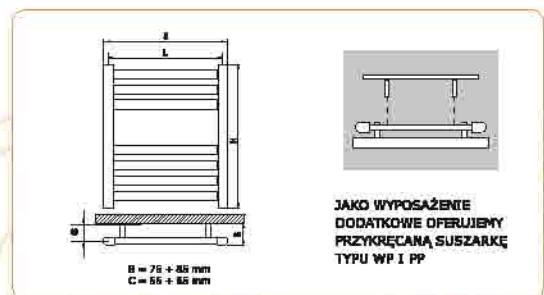

	Pow.	H	S	L	Masa	Poj.	Moc (W)	
							WYKORCZ	TAJASZCZ
AD1-400/EP/Cr	0,27	415	450	400	3,0	0,6	140	110
AD2-400/EP/Cr	0,48	715	450	400	6,5	1,3	230	185
AD3-400/EP/Cr	0,60	850	450	400	7,1	1,7	280	225
AD4-400/EP/Cr	0,72	1060	450	400	9,6	2,5	330	260
AD5-400/EP/Cr	0,86	1240	450	400	10,8	3,1	405	325
AD6-400/EP/Cr	1,00	1450	450	400	12,0	3,3	460	370
AD7-400/EP/Cr	1,15	1630	450	400	13,8	4,8	525	420
AD1-500/EP/Cr	0,32	415	550	500	4,0	1,1	175	140
AD2-500/EP/Cr	0,56	715	550	500	7,5	2,4	280	225
AD3-500/EP/Cr	0,70	850	550	500	8,3	2,9	345	275
AD4-500/EP/Cr	0,84	1060	550	500	11,0	3,4	405	325
AD5-500/EP/Cr	1,01	1240	550	500	12,6	4,1	490	395
AD6-500/EP/Cr	1,16	1450	550	500	14,0	4,9	560	445
AD7-500/EP/Cr	1,35	1630	550	500	16,1	5,6	640	510
AD1-600/EP/Cr	0,37	415	650	600	5,0	1,7	210	165
AD2-600/EP/Cr	0,64	715	650	600	8,5	3,5	335	270
AD3-600/EP/Cr	0,80	850	650	600	9,5	4,2	415	330
AD4-600/EP/Cr	0,96	1060	650	600	12,4	5,0	490	390
AD5-600/EP/Cr	1,16	1240	650	600	14,4	6,0	590	470
AD6-600/EP/Cr	1,33	1450	650	600	16,0	7,1	665	530
AD7-600/EP/Cr	1,55	1630	650	600	18,4	8,1	770	620



Grzejnik występuje również w wersji: AD/L AT/L

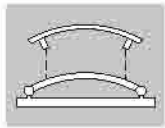

JAKO WYPOSAŻENIE DODATKOWE OFERUJEMY PRZYKRĘCĄ SUSZARKĘ TYPU WL

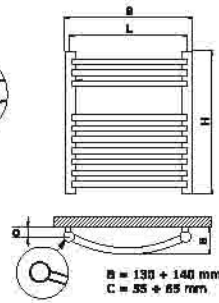
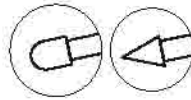

A/L/Cr

45

A/P/Cr



Grzejnik występuje również w wersji: AD/P AT/P

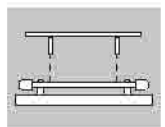

JAKO WYPOSAŻENIE DODATKOWE OFERUJEMY PRZYKRĘCĄ SUSZARKĘ TYPU WP I PP

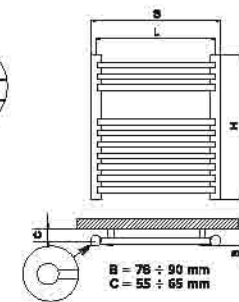
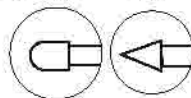

Grzejnik występuje również w wersji: AD/L AT/L

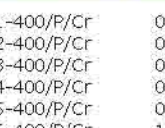

JAKO WYPOSAŻENIE DODATKOWE OFERUJEMY PRZYKRĘCĄ SUSZARKĘ TYPU WL

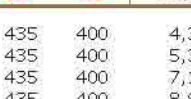

Grzejnik występuje również w wersji: AD/P AT/P



JAKO WYPOSAŻENIE DODATKOWE OFERUJEMY PRZYKRĘCĄ SUSZARKĘ TYPU WP I PP

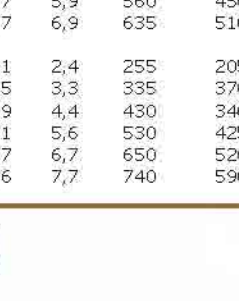

	Pow.	H	S	L	Masa	Poj.	Moc (W)	
							15/20/25	20/25/30
A1-400/L/Cr	0,37	490	435	400	3,9	1,8	190	150
A2-400/L/Cr	0,49	680	435	400	4,6	2,3	250	200
A3-400/L/Cr	0,67	870	435	400	6,6	3,3	335	270
A4-400/L/Cr	0,78	1060	435	400	7,8	4,0	400	320
A5-400/L/Cr	0,95	1250	435	400	9,6	1,9	480	385
A6-400/L/Cr	1,16	1440	435	400	11,7	5,9	545	435
A1-500/L/Cr	0,42	490	535	500	4,5	2,2	225	180
A2-500/L/Cr	0,55	680	535	500	5,2	2,7	300	240
A3-500/L/Cr	0,75	870	535	500	7,5	3,8	400	320
A4-500/L/Cr	0,88	1060	535	500	8,9	4,6	470	375
A5-500/L/Cr	1,08	1250	535	500	11,0	5,6	570	455
A6-500/L/Cr	1,32	1440	535	500	13,4	6,8	650	520
A1-600/L/Cr	0,51	490	635	600	5,0	2,5	245	195
A2-600/L/Cr	0,64	680	635	600	5,8	3,1	350	280
A3-600/L/Cr	0,86	870	635	600	8,4	4,4	470	375
A4-600/L/Cr	1,01	1060	635	600	10,0	5,2	565	455
A5-600/L/Cr	1,24	1250	635	600	12,4	6,3	670	540
A6-600/L/Cr	1,52	1440	635	600	15,1	7,8	760	610



	Pow.	H	S	L	Masa	Poj.	Moc (W)	
							15/20/25	20/25/30
A1-400/P/Cr	0,35	490	435	400	4,3	1,8	185	150
A2-400/P/Cr	0,42	680	435	400	5,3	2,5	245	195
A3-400/P/Cr	0,58	870	435	400	7,1	3,3	310	245
A4-400/P/Cr	0,67	1060	435	400	8,9	4,2	390	310
A5-400/P/Cr	0,82	1250	435	400	10,6	5,1	470	375
A6-400/P/Cr	1,05	1440	435	400	11,8	6,1	535	430
A1-500/P/Cr	0,38	490	535	500	4,6	2,1	220	175
A2-500/P/Cr	0,51	680	535	500	5,8	2,9	290	230
A3-500/P/Cr	0,69	870	535	500	7,8	3,9	370	300
A4-500/P/Cr	0,81	1060	535	500	9,7	4,9	460	370
A5-500/P/Cr	1,00	1250	535	500	11,7	5,9	560	450
A6-500/P/Cr	1,26	1440	535	500	13,7	6,9	635	510
A1-600/P/Cr	0,45	490	635	600	5,1	2,4	255	205
A2-600/P/Cr	0,60	680	635	600	6,5	3,3	335	270
A3-600/P/Cr	0,81	870	635	600	8,9	4,4	430	340
A4-600/P/Cr	0,95	1060	635	600	10,1	5,6	530	425
A5-600/P/Cr	1,16	1250	635	600	12,7	6,7	650	520
A6-600/P/Cr	1,41	1440	635	600	15,6	7,7	740	590





# PRZYKŁADY WZORÓW NA SZKLE



46 Więcej wzorów na [www.radeco.com.pl](http://www.radeco.com.pl)





## rodzaje kamieni

### granit



black graffiti satyan



crown capuchino



giallo san francisco



giallo santa cecylia



golden leaf



rosas vanga



sibirskuzhi poler



japanska yellow easy



kashmir white



madurai gold



nero assoluto



red tiger



sibirskuzhi entice



sibirskuzhi poler

### marmur



bianco carrara



dolno reale elwano



dolno reale jasne



marinace



forest brown antique



forest green



merom imperial

### trawertyn



travertino rojo



travertino rosso



travertino neutro

Kamień jest produktem naturalnym i charakteryzuje się niestabilnością zarówno w ubarwieniu jak i użyciu, dlatego nie ponosimy odpowiedzialności za zmienność produktu wynikającą z jego natury.



## dodatki retro

1



2



3



4



5



6



7



8



9



10



11



12



13



14



15



16



17



18



19



20



21





GRZEJNIKI STANDARD

MODEL AD/RE



MODEL A/1



MODEL A/2



MODEL A/M



MODEL A/U



MODEL AD/UE



MODEL AD/EL



MODEL AD/EP



MODEL A/L



MODEL AD/L



MODEL AD/LE



MODEL AT/L



## GRZEJNIKI STANDARD

MODEL A/T



MODEL A/G



MODEL A/K



MODEL A/KE



MODEL A/B



MODEL A/D

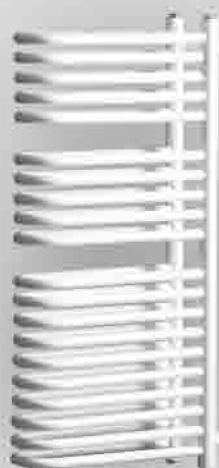

MODEL A/N



MODEL A/Z

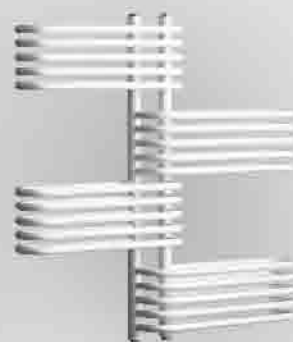

MODEL A/W



MODEL A/P



MODEL AD/P



MODEL AT/P





## grzałki HEATPOL Z REGULATOREM TEMPERATURY

Jako wyposażenie dodatkowe do grzejników proponujemy grzałki elektryczne. Jest to tani i praktyczny sposób na dogrzanie pomieszczeń w okresach przejściowych oraz suszenia ręczników. Grzałki mogą być stosowane w grzejnikach łazienkowych i dekoracyjnych.

Grzałka może być zastosowana zarówno w grzejniku już podłączonym do instalacji centralnego ogrzewania, jak i stanowić z grzejnikiem samodzielny element grzewczy (jako grzejnik elektryczny).

W ofercie posiadamy grzałki:

- model GTN – podstawowy model z regulatorem mechanicznym, pozwalający na płynną regulację temperatury w zakresie 0-65 stopni C.
- model GE – grzałka zbliżona wyglądem do modelu GTN, wyposażona w elektroniczny regulator temperatury. Model ten pozwala na płynną regulację temperatury wody w grzejniku (w zakresie 0-65 stopni C) oraz posiada funkcję Turbo (maksymalne grzanie przez okres 1, 2 lub 3 godzin). Dodatkowo grzałki dają możliwość rozłączenia sterownika od elementu grzejnego.
- model IR – najbardziej zaawansowana grzałka, sterowana i programowana na podczerwieć. Pozwala regulować temperaturę powietrza w łazience (w zakresie 0 – 30st C). Dodatkowo istnieje możliwość pełnego zaprogramowania pracy grzałki w trybie dobowym oraz tygodniowym. Model wyposażony także w funkcję Turbo (proste grzanie, suszenie).

Wszystkie grzałki dostępne są w mocach 300, 600, 900, 1200 i 1500W oraz w kolorach: biały, chrom, satyna oraz złoto (retro – mosiądz).



TYP	Gwint	Moc [W]
obudowa biała	<b>GTN</b>	
GT-0,3N	R 1/2"	300 W
GT-0,6N	R 1/2"	600 W
GT-0,9N	R 1/2"	900 W
GT-1,2N	R 1/2"	1200 W



TYP	Gwint	Moc [W]
obudowa chromowana	<b>GTM</b>	
GTM-0,3N	R 1/2"	300 W
GTM-0,6N	R 1/2"	600 W
GTM-0,9N	R 1/2"	900 W
GTM-1,2N	R 1/2"	1200 W



TYP	Gwint	Moc [W]
obudowa biała	<b>GE</b>	
GE-0,3	R 1/2"	300 W
GE-0,6	R 1/2"	600 W
GE-0,9	R 1/2"	900 W

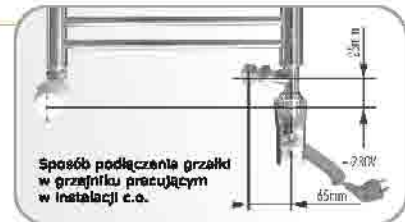

## wieszaki na grzejniki

**LIU**  
wieszak międzyrurowy przykręcany - biały



**LIU**  
wieszak międzyrurowy przykręcany - chrom



**BIAGIO**  
wieszak magnetyczny - biały



**BIAGIO**  
wieszak magnetyczny - chrom



**HOOK**  
wieszak narurkowy - biały



**HOOK**  
wieszak narurkowy - przezroczysty



**HOOK**  
wieszak narurkowy - chrom



**AGA**  
wieszak międzyrurowy przykręcany - biały



**AGA**  
wieszak międzyrurowy przykręcany - chrom



**MONICA**  
wieszak magnetyczny - biały



**MONICA**  
wieszak magnetyczny - chrom



**FLEX**  
wieszak oddeptylany międzyrurowy - biały



**FLEX**  
wieszak oddeptylany międzyrurowy - chrom



**IRENE**  
wieszak przykręcany do ściany - biały



**IRENE**  
wieszak przykręcany do ściany - chrom



**COBRA**  
wieszak do kablnych przysięgowych - biały



**COBRA**  
wieszak do kablnych przysięgowych - przezroczysty



**COBRA**  
wieszak do kablnych przysięgowych - chrom



**BOA**  
wieszak do kablnych przysięgowych - biały



**BOA**  
wieszak do kablnych przysięgowych - przezroczysty



**BOA**  
wieszak do kablnych przysięgowych - chrom



**CLIP** wieszak do grzejników aluminiowych



## EXCLUSIVE



zestaw łazienkowy - biały  
(kątowy, osłowo prawy lub lewy)  
za złączką na PEX lub Cu



zestaw łazienkowy - satyna  
(kątowy, osłowo prawy lub lewy)  
za złączką na PEX lub Cu



zestaw łazienkowy - chrom  
(kątowy, osłowo prawy lub lewy)  
za złączką na PEX lub Cu



zestaw łazienkowy - antyczny mosiądz  
(kątowy, osłowo prawy lub lewy)  
za złączką na PEX lub Cu

### PRZYŁĄCZA JEDNOSTWOROWE



białe  
- figura kątowna prawa  
- figura kątowna lewa  
- figura prosta



chrom  
- figura kątowna prawa  
- figura kątowna lewa  
- figura prosta



satyna  
- figura kątowna prawa  
- figura kątowna lewa  
- figura prosta



mosiądz antyczny  
- figura kątowna prawa  
- figura kątowna lewa  
- figura prosta

### ZINTEGROWANE PODEJŚCIA DUO-PLEX



białe



satyna



chrom



antyczny  
mosiądz

## ELEGANT STYLE

Zestawy zaworów grzejnikowych kątowych za złączką na PEX lub Cu.  
W opcji element drewniany.

biały



satyna



chrom



antyczny  
mosiądz



## ELEGANT

Zestawy zaworów grzejnikowych (kątowne lub proste) za złączką na PEX lub Cu



białe



satyna



chrom



antyczny  
mosiądz

## PRESTIGE

Zestawy termostaticzne kątowne za złączką na PEX lub Cu.

biały



satyna



chrom



antyczny  
mosiądz



## STANDARD



Zawór termostacyjny  
prosty



Zawór termostacyjny  
kątowny



Zawór termostacyjny  
osłowo prawy



Zawór termostacyjny  
osłowo lewy



Zawór powrotny kątowny



Zawór powrotny prosty



Design  
program



*Nowy wymiar ciepła*

grzejniki łazienkowe

**radeco**<sup>®</sup>

[www.radeco.com.pl](http://www.radeco.com.pl)



CE

07

producent:

„ALPLAST” s.j.  
ul. Rynkowska 2  
85-506 Bydgoszcz

tel.: 52 327 22 22 wew. 18, 20  
52 327 22 23 wew. 18, 20

fax: 52 327 22 23 wew. 15  
52 327 22 24

e-mail: [handlowy@alplast.pl](mailto:handlowy@alplast.pl), [biuro@alplast.pl](mailto:biuro@alplast.pl)

dysytributor:

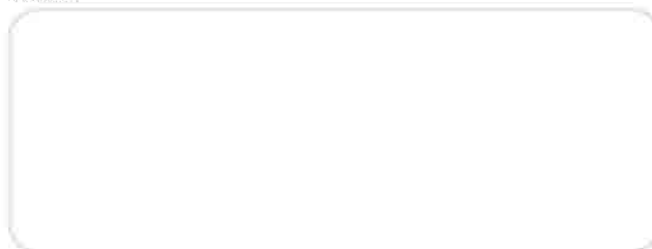

projekt: [www.radeco.com.pl](http://www.radeco.com.pl)