



**Arbiton**  
FLOOR EXPERT



FLOORING COLLECTION 2022

[www.arbiton.com](http://www.arbiton.com)

# WE ARE THE FLOOR EXPERTS

**\_WE CREATE**  
**\_WE TEST**  
**\_WE PRODUCE**

From the beginning, we were guided by the idea to create products that will be perfect. Our goal was to create the perfect floor - one that combines the best features of ceramic tiles and the beauty and warmth of natural wood.

We have been creating, testing and improving our products for over 20 years. The Arbiton brand is the result of a titanic work of hundreds of people. Arbiton combines all our experience and guarantees high quality.

We know everything about vinyl floors. This is because we deal with the product from the very first drawing to the final testing.

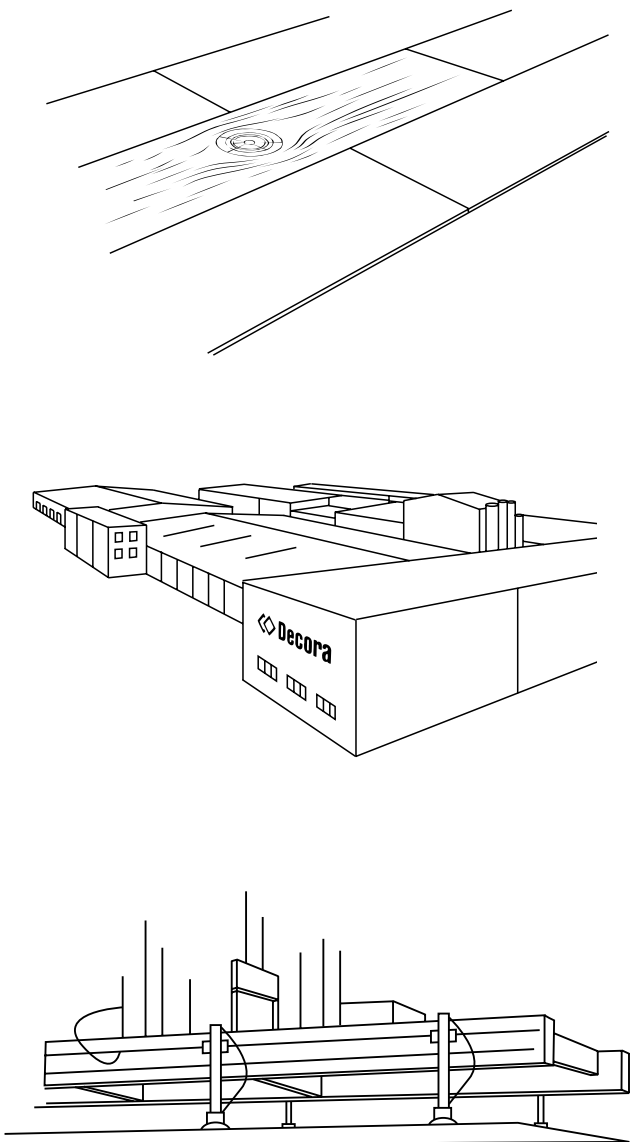

---

Our A.design studio is responsible for unique decor patterns, inspired by the most beautiful varieties of wood from around the world. Engineers develop products that provide better and better technical parameters. Production Team and Quality Control ensures that our vinyl floors are the same, highest quality every single time. Our own laboratory is testing thousands of samples every year so we can offer you the best vinyl floor system on the market.

We know not only how to produce panels, but also how to install them and care for them. When you buy Arbiton floors, you will receive not only an excellent product with perfect technical parameters, but also a professional team of experts who take care of the after-sale service at every step.



# TABLE OF CONTENT

_6	THE FLOOR FOR THE MODERN TIMES
_10	BEAUTIFUL AND PRACTICAL
_14	HD MINERAL CORE® TECHNOLOGY
_16	TITANIUM NANO LAYER
_20	TOOLS FOR THE MODERN TIMES
_22	<b>COLOR SHADES</b>
	LIGHT GREY
	DARK GREY
	BLEACHED OAK
	LIGHT NATURAL
	NATURAL
	DARK NATURAL
_28	<b>COLLECTIONS</b>
	AMARON HERRINGBONE
	AMARON SUPERIORE
	AMARON WOOD DESIGN
	XXL AMARON STONE DESIGN
	LIBERAL
	AROQ WOOD DESIGN
	AROQ STONE DESIGN
_58	<b>ACCESSORIES</b>
	SKIRTING BOARDS
	UNDERLAYS
	FLOOR PROFILES





LEONARD OAK  
CL 156

# THE FLOOR FOR THE **MODERN TIMES**



**\_DESIGN**  
IN EVERY DETAIL

---

**\_REAL WOOD SELECTED**  
BY A.DESIGN STUDIO

---

**\_MATCHING TO THE LATEST**  
**TRENDS IN INTERIOR**  
**DESIGN**

---

YANKEE OAK  
CA 153



**\_SCRATCH FREE WITH  
TITANIUM NANO LAYER**

---

**\_PRACTICAL FEATURES OF  
HD MINERAL CORE®**

---

**\_EFFECTIVE FLOOR  
HEATING**

---

# ONE SPACE ONE FLOOR

**\_UP TO 200 m<sup>2</sup>  
WITHOUT  
DILATATION**

*\* see installation manual*

**\_LIVING  
ROOM**

**\_KITCHEN**

**\_HALL**



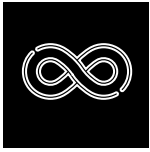

Thanks to its usability our floor is dedicated to open space interiors.  
Open kitchen with a living room is the heart of your home and with our  
HD Mineral Core® solution your floor will stay strong and beautiful for years.



BAKER CONCRETE  
CA 151

# THE FLOOR FOR THE MODERN TIMES

## \_BEAUTIFUL AND PRACTICAL

Modern times become more and more hectic, full of challenges and responsibilities. We live fast, trying to make the most of every single moment. We are pushed to look for new solutions, technologies and clever ways to adjust items all around us to meet needs and expectations. With this in mind, **Arbiton HD Mineral Core®** floor was created. This floor impresses and surprises with practicality. Inspired by nature, vinyl floors are entirely designed by European A.Design Studio. Created for people just like you, who get the most out of each moment and enjoy the life to the fullest. The Arbiton floor design not only matches the latest trends, but also go ahead of times and creates them. Thanks to the timeless design its beauty will amaze you every day.



The pace of our life direct us towards solutions that will support and enhance us in everyday situations. That is why **Arbiton HD Mineral Core®** floors have been designed for their maximum comfort of use. Due to their advanced technical properties, they can be installed in any room without expansion joints between rooms. This allows to have beautiful, unified floor throughout the whole level of the apartment. With complete waterproofness and low thermal impedance they are perfect to fit in bathrooms with underfloor heating. They are easy to clean and antistatic, which prevents dust from adhering to them. Moreover, thanks to the innovative Titanium Nano Layer they are up to 30% more scratch resistant. All of these features and properties mean that you get a floor which will meet the demands of our time. With Arbiton floor you can enjoy life thanks to not only its beauty but also a peace of mind with guaranteed unique functional properties.



PASADENA OAK  
CL 107



# BEAUTIFUL AS WOOD



WILIAMSBURG  
CA 114

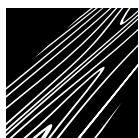

## \_REAL WOOD STRUCTURE

Unique and realistic wood design selected from the most beautiful wood type in the world.



## \_WIDE BOARD

The widest plank available on the market - 229 mm - beautiful and the most natural looking floor.

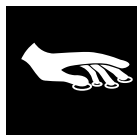

## \_SOFT TOUCH

Soft, delicate and mat finished flooring - the best representation of a real wood.



## \_SILENT FLOOR

Nice and silent in everyday use vinyl flooring brings comfort and serenity to everyday life.

# PRACTICAL AS CERAMIC TILES



PASADENA OAK  
CL 107



## **\_ DURABILITY+STRONGER LOCKING SYSTEM**

HD Mineral Core® primarily means extremely strong locking system which gives the whole flooring system a maximum durability. Despite of small thickness of the plank our locks are 2 times stronger than average LVT locks available on the market.

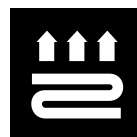

## **\_ UNDERFLOOR HEATING**

Very low thermal resistance of our floors means more effective use of the underfloor heating system. Thanks to HD Mineral Core® less fuel is needed for floor heating and over 60% less carbon is released into the atmosphere from one household in Europe, each year.



## **\_ WATERPROOF**

No need to be scared of water. Our floors are 100% waterproof. Frequent cleaning or spilled drinks are no longer dangerous to your floor. Without concerns you can connect your kitchen floor with the rest of your living space.

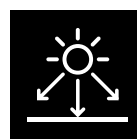

## **\_ DIMENSIONAL STABILITY**

HD Mineral Core® also means high dimensional stability of the floor even in very sunny rooms. We offer at least 2 times higher dimensional stability of our floors in comparison to traditional LVT.

**DIMENSIONAL STABILITY**  
(EN ISO 23999) up to 0,05%

# HD MINERAL CORE® TECHNOLOGY



In our laboratories we've discovered an innovative combination of natural rock minerals and advanced polymers. Carefully combined proportions ensure maximum performance of the floor. Our HD Mineral Core® provides extreme durability which we confirm by giving you 20 year guarantee. We are proud of the quality of our products free of phthalates and harmful plasticizers.



**Hardness  
and durability  
of natural rock minerals**

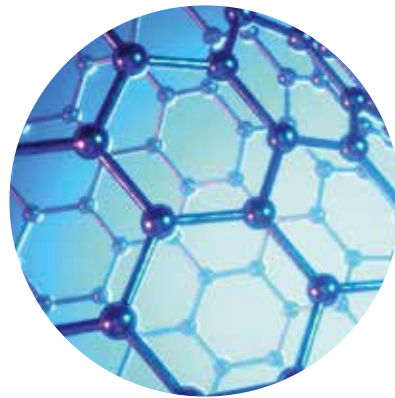

**The flexibility  
of modern polymers based  
on carbon molecules**

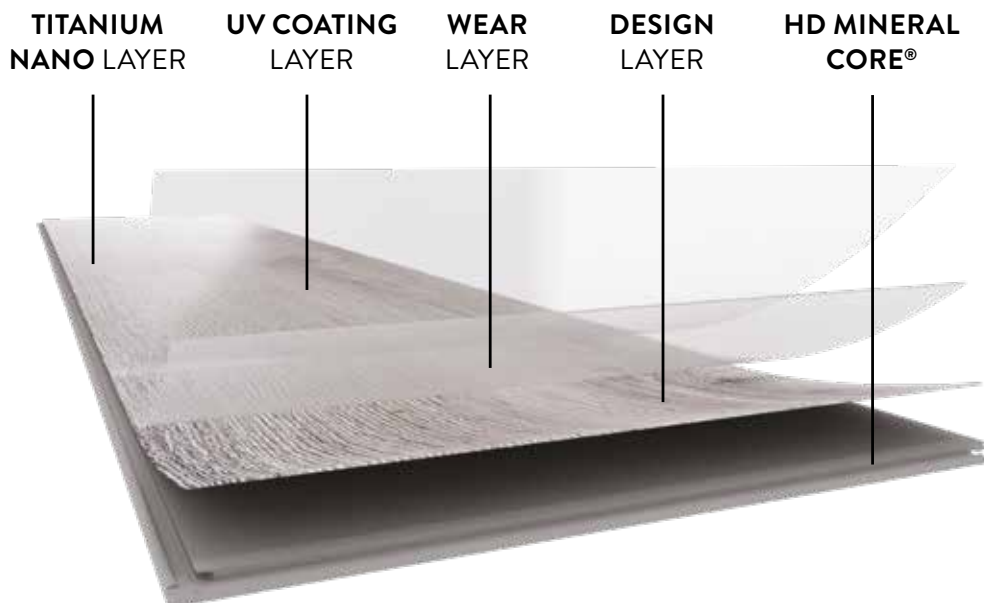

# TITANIUM NANO LAYER

## What makes the floor durable?

The answer cannot be simpler: it should remain intact for years without visible wear and deterioration signs. To achieve that many technical parameters and features need to be considered that will affect the entire floor system. Different properties are essential for load resistance and different ones for compression. Strong locking system supported by well-matched underlay keep the panels in place. Water resistance is also a factor affecting longevity of the floor. On the one hand it protects from accidents like failure of a washing machine or water spillage but on the other hand it makes it easy to maintain clean. Scratch resistance is especially important from durability perspective. So far, it was a weak point of vinyl flooring in comparison to laminated floors. This time is over with the Titanium Nano Layer introduction.



**30%  
MORE**  
RESISTANT SURFACE\*

\* test method according to EN1518







FLOOR WITH  
**TITANIUM NANO LAYER**



STANDARD  
**LVT**

For last couple of years, professional car workshops offer protection of a paint layer. For additional fee, we can protect the paint coating with specially selected cosmetics. This service is mostly done on the new car even before it has left the dealership. The factory lacquer coating is being covered with ceramic or nanoparticles coating. This offer satisfy the most demanding customers who want to enjoy the beautiful appearance of the car for years. Titanium Nano Layer is inspired by these premium automotive detailing process. Titanium Nano Layer protects the panels and secure them against micro scratches that can occur in the regular lifespan of use. The Titanium Nano Layer protective coating is available in the top Arbiton collections - Amaron and Liberal. Technology used in these collections outperform in durability and scratch-resistance tests the majority of vinyl panels on the market. As a result sand, earth or even mud are a danger no longer because of the Titanium Nano Layer and waterproofness. This means that Arbiton Amaron and Liberal can be easily installed in kitchens, dining rooms or even in bathrooms. And all these rooms can be unified – up to 200 m<sup>2</sup> without additional expansion joints. The combination of HD Mineral Core® and Titanium Nano Layer guarantees a beautiful floor for many years.



# NATURAL SYNCHRONE STRUCTURE

For those who appreciate super-realistic wood structure, perfectly synchronized with the decor, we have prepared an absolute novelty. NATURAL SYNCHRONE STRUCTURE - structure of the EIR type (embossed in register), the first of its kind in panels with a mineral core. Beautiful and delicate to the touch with a supermat surface, it will be perfect for large, spacious rooms with natural light. Available in the AMARON SUPERIORE collection.

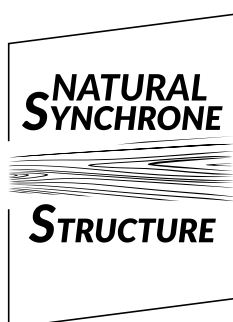

**\_DEEP MATT  
SURFACE**

---





**\_EMBOSSSED  
IN REGISTER**

# TOOLS FOR THE MODERN TIMES

Go to our website and the floor selection will become much easier. On our website we provide a free floor visualization tool. It is the fastest and most accurate floor visualizer in Europe. Without the need to download any app: just enter **arbiton.com**



**TAKE  
A PHOTO  
OF YOUR ROOM**



**CHOOSE  
FLOOR  
DESIGN**



**SEE  
IT LIVE!**



BEFORE / AFTER



BEFORE / AFTER



BEFORE / AFTER



All you need to do is to take a photo of the room and go to [www.arbiton.com](http://www.arbiton.com). Upload a photo and choose floors from a very wide set of decors and colors. The visualizer can be conveniently used with a mobile phone, without having to download any application first. The visualizer perfectly reproduces the issues of light, shadows, as well as the structure

of the room. It also recognizes objects on the floor, chair and table legs and other pieces of furniture that are part of the interior.

A real revolution already changing consumer behaviour in the construction segment.

# COLOR SHADES



WILIAMSBURG  
CA 114

## COLOR SHADE / LIGHT GREY



## COLOR SHADE / DARK GREY

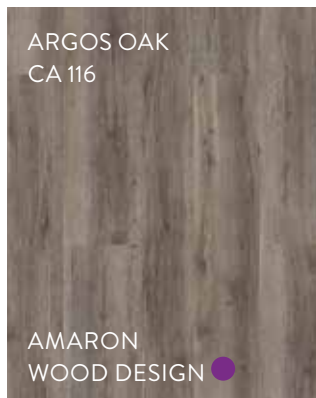
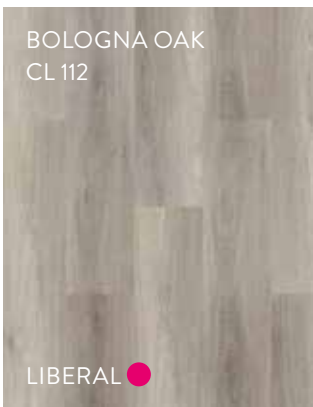

## COLOR SHADE / BLEACHED OAK

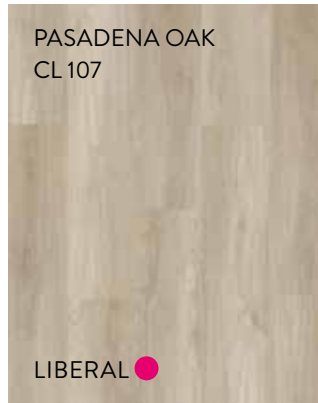

## COLOR SHADE / LIGHT NATURAL

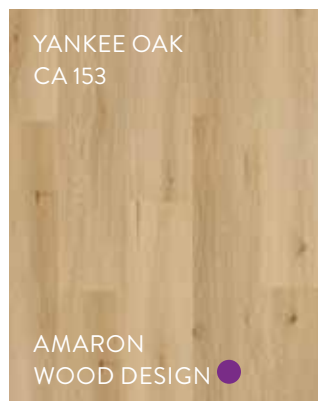
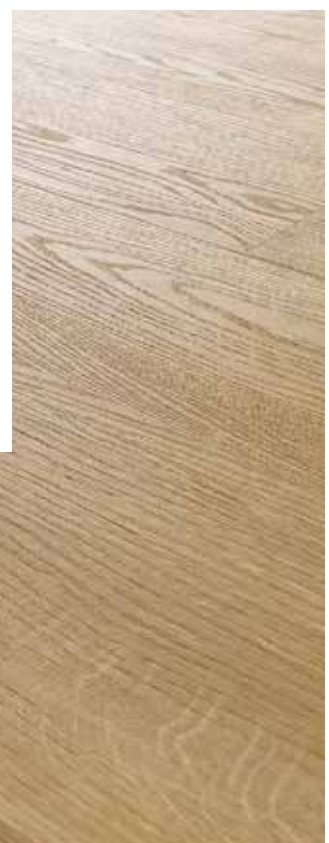
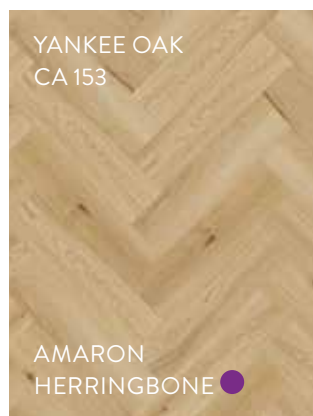
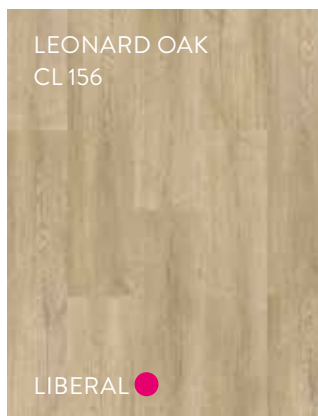
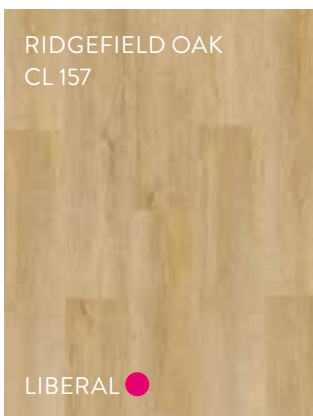



# COLOR SHADE / NATURAL

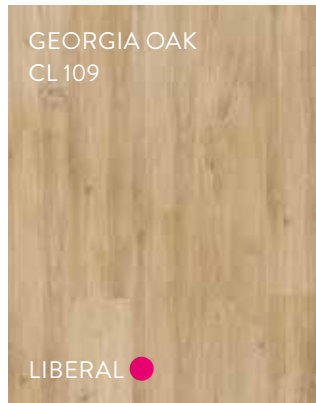
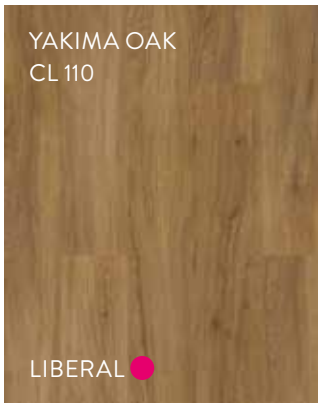
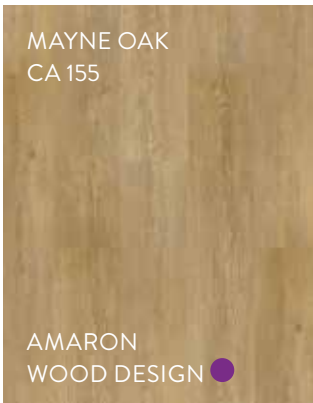
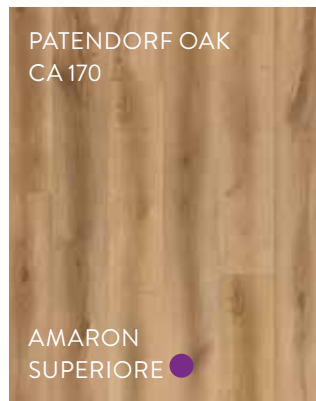
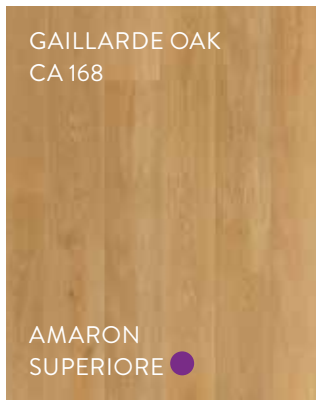
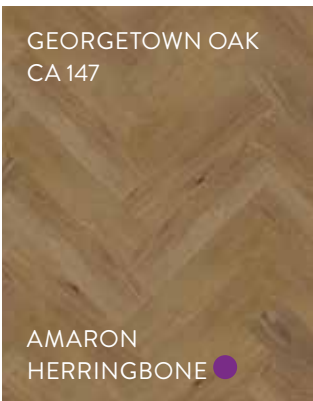
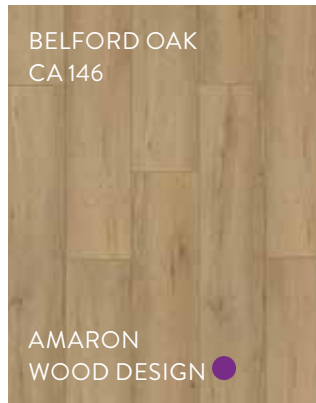
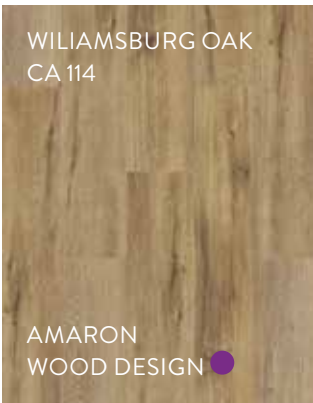

COLOR SHADE / **DARK NATURAL**



GRANTS OAK  
CA 148

AMARON  
WOOD DESIGN 

GRANTS OAK

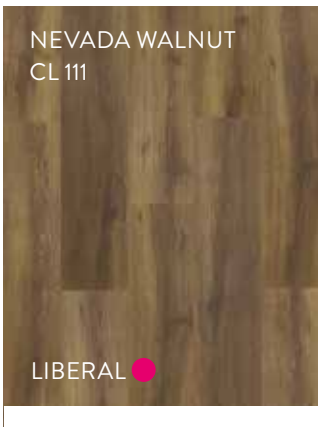

NEVADA WALNUT  
CL 111

LIBERAL 



NEVADA WALNUT

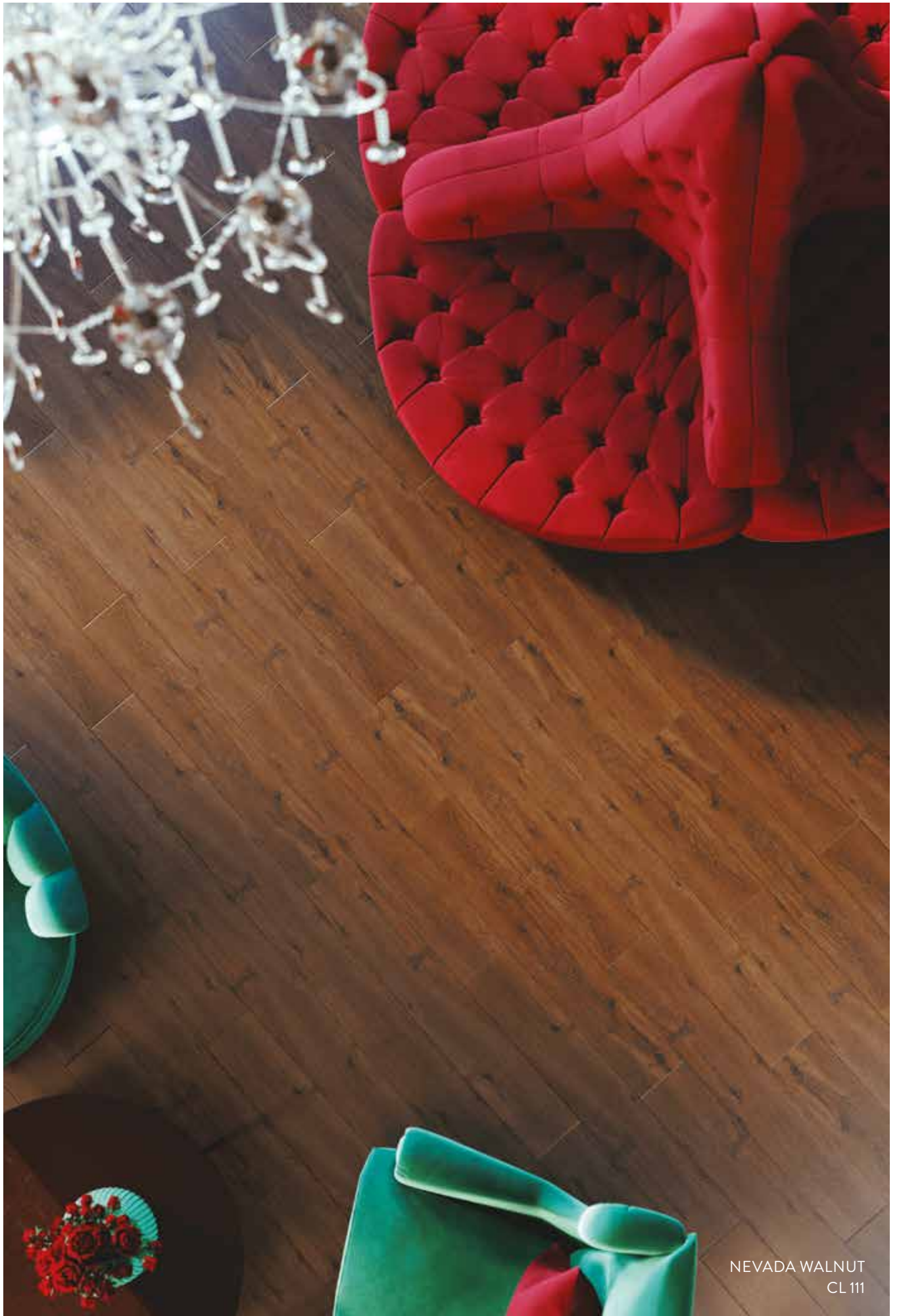

NEVADA WALNUT  
CL 111

# SIZE DOES MATTER

**AMARON SUPERIORE DESIGN**  
229 mm x 1830 mm



**AMARON WOOD DESIGN**  
229 mm x 1511 mm



**AMARON XXL STONE DESIGN**  
457 mm x 914 mm



**NEW**  
**AMARON HERRINGBONE**  
148 mm x 592 mm

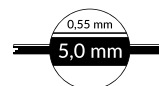



**LIBERAL**

229 mm x 1220 mm



**AROQ WOOD  
DESIGN**

152 mm x 914 mm



**AROQ STONE  
DESIGN**

305 mm x 610 mm

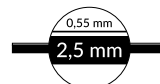

# AMARON HERRINGBONE



WEMBLEY OAK  
CA 159

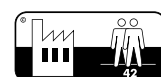
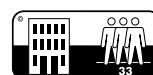
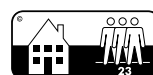
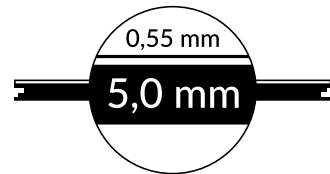
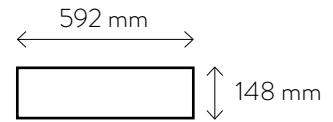

# AMARON HERRINGBONE



Fashion passes- just to return later. Trends come and go but precious few hold on for a long time. Our Amaron Herringbone vinyl click floor is designed to belong to the latter group. Thanks to specially designed locking system this collection might be arranged in the iconic English herringbone pattern. This is an amazing way to adjunct traditional interior arrangements. The main element that indicates the direction of the interior style is the floor – any further decisions regarding the interior are based upon it. Furniture, textures, fabrics, accessories – all of those either correspond to the selected floor or stay in opposition on the basis of divergence. Regardless of which approach you choose, you can stay calm knowing that the Arbiton panels will secure you the highest quality.



**PRESTON OAK**

**CA 167**



EAN: 5905167839348

Plank size: 592 mm x 148 mm



**HARLOW OAK**

**CA 158**



EAN: 5905167826676

Plank size: 592 mm x 148 mm



**WEMBLEY OAK**

**CA 159**



EAN: 5905167826683

Plank size: 592 mm x 148 mm



**YANKEE OAK**

**CA 153**



EAN: 5905167839324

Plank size: 592 mm x 148 mm



**GEORGETOWN OAK**

**CA 147**



EAN: 5905167839331

Plank size: 592 mm x 148 mm



YANKEE OAK  
CA 153





# AMARON SUPERIORE



**LONG PLANK**

1830 mm

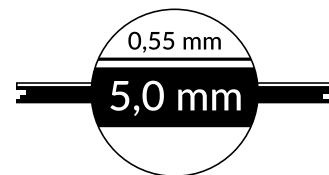
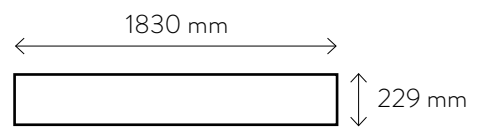
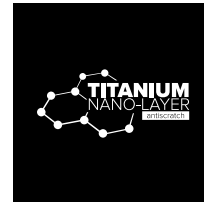

# AMARON SUPERIORE



A collection created for the most demanding. The largest panel available, 1830mm long and 229mm wide. Additionally, NATURAL SYNCHRONE STRUCTURE, faithfully reflects natural wood. In four delightful designs, beautiful natural shades of oak. The perfect floor, created for perfect interiors.



**GAILLARDE OAK**

**CA 168**



EAN: 5905167839355

Plank size: 1830 mm x 229 mm



**WEISSHORN OAK**

**CA 169**



EAN: 5905167839362

Plank size: 1830 mm x 229 mm



**PATENDORF OAK**

**CA 170**



EAN: 5905167839379

Plank size: 1830 mm x 229 mm



**STAMBERGER OAK**

**CA 171**



EAN: 5905167839386

Plank size: 1830 mm x 229 mm





PATENDORF OAK  
CA 170

# AMARON WOOD DESIGN



MAYNE OAK  
CA 155

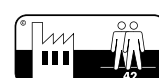
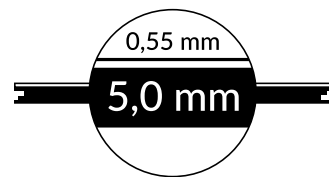
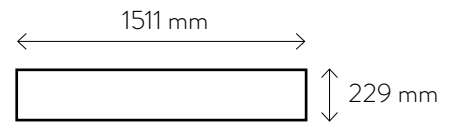
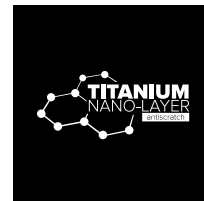

# AMARON WOOD DESIGN



Amaron WOOD means expressive designs which will create the character of the interior. The floors in this collection have the highest usage class, created for the most demanding customers. This floor will play first fiddle. The 5G lock makes the floor easy and fast to install. A beautiful floor is a crucial element of interior design. It brings character to the unified design or lets you play a bit with contrast in modern or typically loft interiors. In any way, the floor is the element that helps to create an interesting space- where colours, textures and shapes result in the imagined effect- a sense of harmony and undisputed beauty. Having that in mind, we have created Amaron Wood vinyl click floor.



**ALASKAN OAK**

**CA 102**

EAN: 5905167798508

Plank size: 1511 mm x 229 mm



**LAHTI OAK**

**CA 117**

EAN: 5905167798553

Plank size: 1511 mm x 229 mm



**OREGON OAK**

**CA 115**

EAN: 5905167798539

Plank size: 1511 mm x 229 mm



**ARGOS OAK**

**CA 116**

EAN: 5905167798546

Plank size: 1511 mm x 229 mm



**WELLINGTON OAK**

**CA 145**

EAN: 5905167814871

Plank size: 1511 mm x 229 mm



**PANAMA OAK**

**CA 113**

EAN: 5905167798515

Plank size: 1511 mm x 229 mm



**YANKEE OAK**

**CA 153**

EAN: 5905167824191

Plank size: 1511 mm x 229 mm



**SIERRA OAK**

**CA 154**

EAN: 5905167824207

Plank size: 1511 mm x 229 mm

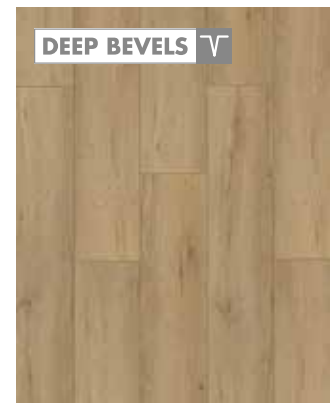

**BELFORD OAK**

**CA 146**

EAN: 5905167814888

Plank size: 1511 mm x 229 mm





**WILIAMSBURG OAK**

**CA 114**

EAN: 5905167798522

Plank size: 1511 mm x 229 mm

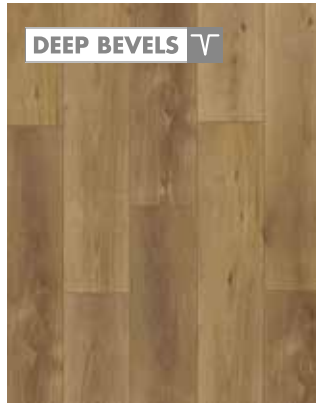

**GEORGETOWN OAK**

**CA 147**

EAN: 5905167814895

Plank size: 1511 mm x 229 mm



**MAYNE OAK**

**CA 155**

EAN: 5905167824214

Plank size: 1511 mm x 229 mm



**GRANTS OAK**

**CA 148**

EAN: 5905167814901

Plank size: 1511 mm x 229 mm



WILIAMSBURG OAK  
CA 114

**XXL  
AMARON  
STONE  
DESIGN**



TOKIO  
CA 150

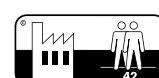
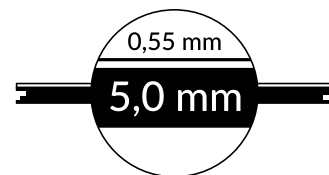
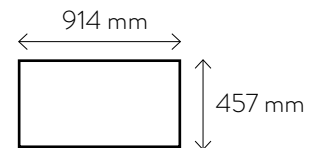

# XXL AMARON STONE DESIGN



Recently, interior designers tend to use solutions inspired by industrial, loft styles, strictly referring to, generally speaking, "urban spaces". This is a trend we have noticed for few years already, and most importantly, it brings really great projects. In most cases, main point of attention in those realisations is the selected range of vinyl flooring. Keeping this in mind, we have decided to create a collection of modern vinyl click panels in stone and concrete designs that are chosen the most and which would align with individual and business customers, professionally engaged in interior design.



**GLACIER CONCRETE**

**CA 149**

EAN: 5905167814918

Plank size: 914 mm x 457 mm

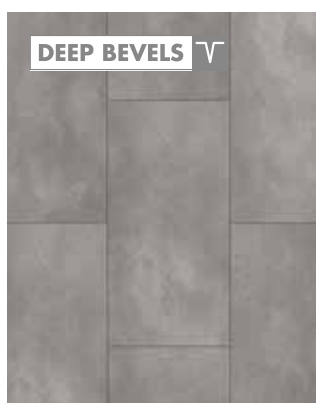

**TOKIO CONCRETE**

**CA 150**

EAN: 5905167814925

Plank size: 914 mm x 457 mm



**BAKER CONCRETE**

**CA 151**

EAN: 5905167814932

Plank size: 914 mm x 457 mm



**HAMBURG CONCRETE**

**CA 152**

EAN: 5905167814949

Plank size: 914 mm x 457 mm



GLACIER CONCRETE  
CA 149



# LIBERAL



LEONARD OAK  
CL 156

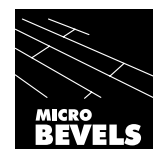
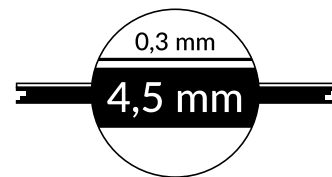
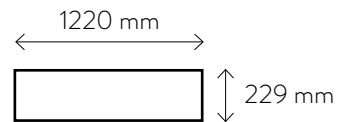
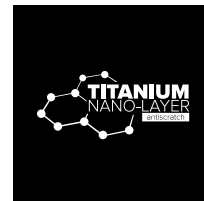

# LIBERAL



A new floor can completely change any interior. In fact, the floor is the heart of composition, so it is worth to thoroughly think upon this choice. You can choose the décor that will catch attention and pop up from the interior or take a different route and choose a much more subtle, an ideal background for stylish furniture. No matter which option you choose, we have prepared a special collection of vinyl click flooring. LIBERAL is the collection designed for customers appreciating superior design and high quality.



**ALASKAN OAK**

**CL 102**

EAN: 5905167798393

Plank size: 1220 mm x 229 mm



**CANADIAN OAK**

**CL 104**

EAN: 5905167798416

Plank size: 1220 mm x 229 mm



**CONEY OAK**

**CL 105**

EAN: 5905167798423

Plank size: 1220 mm x 229 mm



**BOLOGNA OAK**

**CL 112**

EAN: 5905167798492

Plank size: 1220 mm x 229 mm



**PORTLAND OAK**

**CL 106**

EAN: 5905167798430

Plank size: 1220 mm x 229 mm



**PASADENA OAK**

**CL 107**

EAN: 5905167798447

Plank size: 1220 mm x 229 mm



**DAKOTA OAK**

**CL 108**

EAN: 5905167798454

Plank size: 1220 mm x 229 mm



**GEORGIA OAK**

**CL 109**

EAN: 5905167798461

Plank size: 1220 mm x 229 mm





**LEONARD OAK**

**CL 156**



EAN: 5905167824221

Plank size: 1220 mm x 229 mm



**RIDGEFIELD OAK**

**CL 157**



EAN: 5905167824238

Plank size: 1220 mm x 229 mm



**YAKIMA OAK**

**CL 110**



EAN: 5905167798478

Plank size: 1220 mm x 229 mm



**NEVADA WALNUT**

**CL 111**



EAN: 5905167798485

Plank size: 1220 mm x 229 mm



**PASADENA OAK**  
**CL 107**

AROQ  
WOOD  
DESIGN



WILIAMSBURG OAK  
CA 114

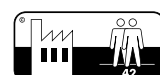
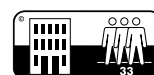
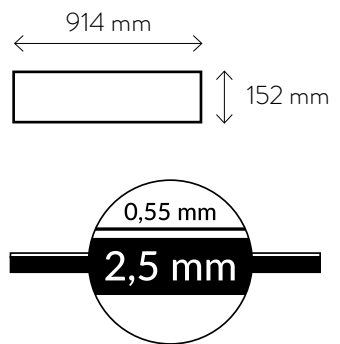

# AROQ WOOD DESIGN



In every home, office or other space the floor is a foundation of finished interior. All major decisions are based on the type of material that would lay on the floor. So it is worth to be sure that applied material is the best possible quality. It can come to a point when the eventual, in which eventual repairing of the damaged floor can cause great engagement of time, labour and cost. In regards to the floor it is worth following the „Once and for all” rule. From the available floor types that makes this rule possible are the glued down vinyl floors called DRYBACK.



**BERGEN OAK**

**DA 103**



EAN: 5905167798621

Plank size: 914 mm x 152 mm



**BOLOGNA OAK**

**DA 112**



EAN: 5905167798638

Plank size: 914 mm x 152 mm



**PASADENA OAK**

**DA 107**



EAN: 5905167798645

Plank size: 914 mm x 152 mm



**WILIAMSBURG OAK**

**DA 114**



EAN: 5905167798652

Plank size: 914 mm x 152 mm



**NEVADA WALNUT**

**DA 111**



EAN: 5905167798669

Plank size: 914 mm x 152 mm



**CAMDEN OAK**

**DA 124**



EAN: 5905167798676

Plank size: 914 mm x 152 mm



BOLOGNA OAK  
DA 112



# AROQ STONE DESIGN



BROOKLYN  
DA 121

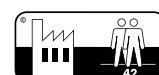
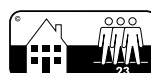
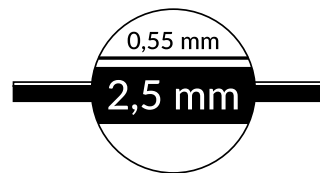
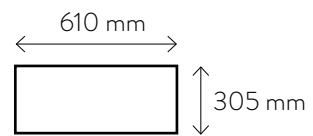

# AROQ STONE DESIGN



In every home, office or other space the floor is a foundation of finished interior. All major decisions are based on the type of material that would lay on the floor. So it is worth to be sure that applied material is the best possible quality. It can come to a point when the eventual, in which eventual repairing of the damaged floor can cause great engagement of time, labour and cost. In regards to the floor it is worth following the „Once and for all” rule. From the available floor types that makes this rule possible are the glued down vinyl floors called DRYBACK.



**SOHO**

**DA 118**

EAN: 5905167798560

Plank size: 610 mm x 305 mm



**TORONTO**

**DA 119**

EAN: 5905167798584

Plank size: 610 mm x 305 mm

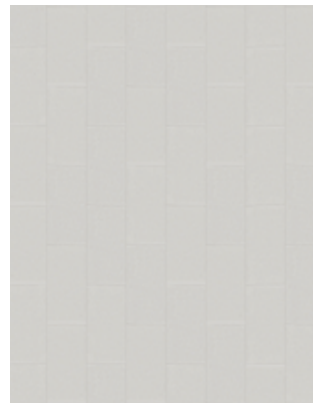

**MIAMI**

**DA 120**

EAN: 5905167798591

Plank size: 610 mm x 305 mm



**BROOKLYN**

**DA 121**

EAN: 5905167798607

Plank size: 610 mm x 305 mm



**BROADWAY**

**DA 122**

EAN: 5905167798614

Plank size: 610 mm x 305 mm



**MANHATTAN**

**DA 123**

EAN: 5905167798577

Plank size: 610 mm x 305 mm



MIAMI  
DA 120





# COMPREHENSIVE FLOORING SYSTEM





**FLOOR  
PROFILES**

# SKIRTING BOARDS

## COLOR MATCHED SKIRTING BOARDS - TORE

TORE is our new SOLID CORE skirtings created in a brand new technology giving it a 100% water resistance as well as a higher abrasion resistance. Due to the highly advanced technology of digital printing, we gained an unprecedented fidelity to raw materials at the surface of the skirtings, which now look like actual wood, stone or concrete. It allowed us for an ideal matching of the design of the skirtings.

With the multistep process of the production TORE gains an ideally matte surface. As a result, skirtings obtain a deep thread design enriching each interior and underlining its beauty. In addition to it, our product is environmentally friendly. The printing technology is based on using the VOC Free and solvent-free paints to guarantee neutrality for the environment. For colors match see page 60.

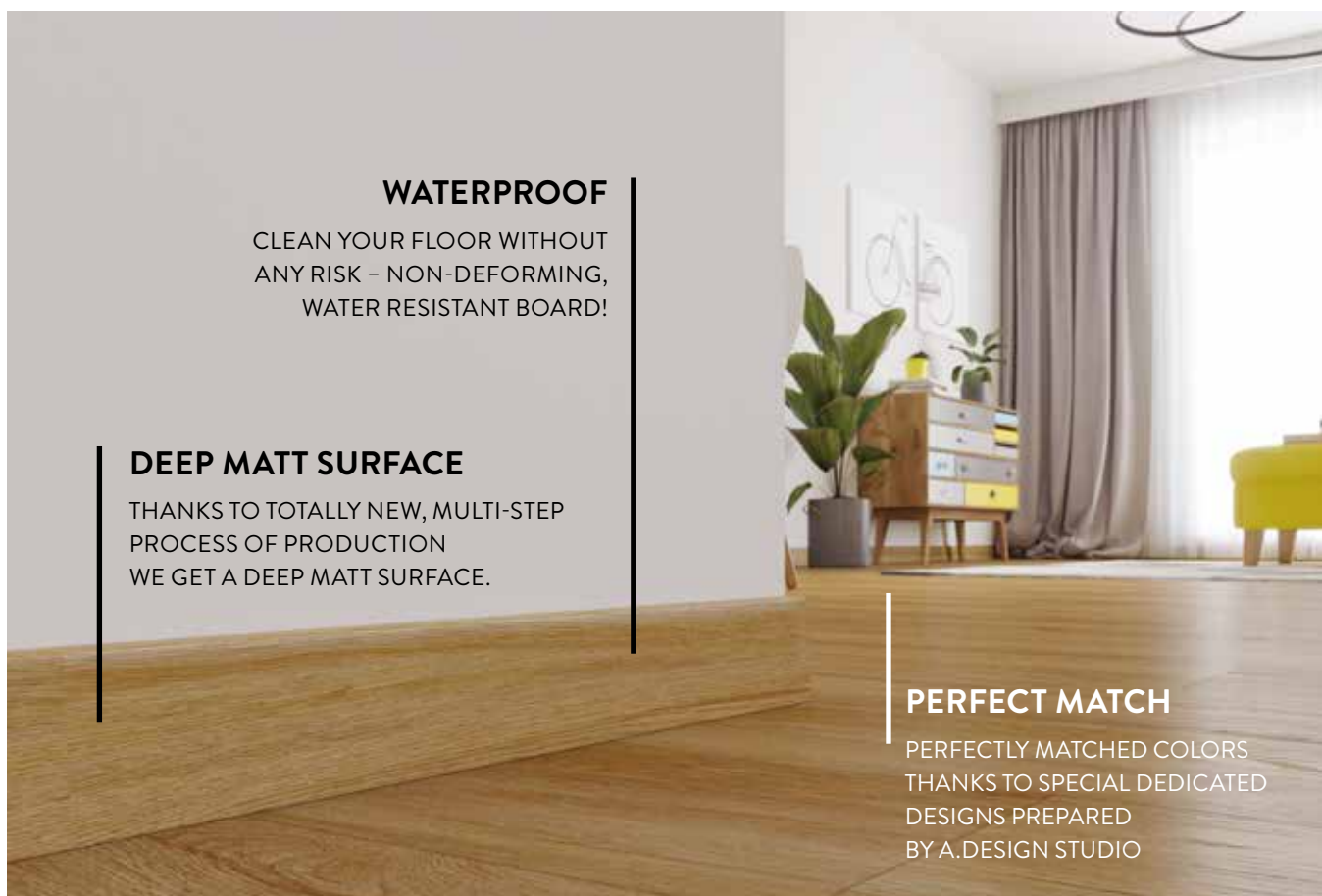

### WATERPROOF

CLEAN YOUR FLOOR WITHOUT ANY RISK – NON-DEFORMING, WATER RESISTANT BOARD!

### DEEP MATT SURFACE

THANKS TO TOTALLY NEW, MULTI-STEP PROCESS OF PRODUCTION WE GET A DEEP MATT SURFACE.

### PERFECT MATCH

PERFECTLY MATCHED COLORS THANKS TO SPECIAL DEDICATED DESIGNS PREPARED BY A.DESIGN STUDIO

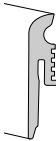
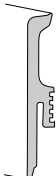
	HEIGHT	WIDTH	LENGTH	100% WATERPROOF	GLUE INSTALLATION	CLIPS INSTALLATION
TORE 60 	58 mm	14 mm	220 cm	✓	✓	✓
TORE 80 	78 mm	14 mm	220 cm	✓	✓	✓

## MONOCOLOR SKIRTING BOARDS - VIGO

Thanks to our solutions we've created the skirting in hybrid technology. Now, you have high quality surface of lacquered MDF skirtings and the flexibility and waterproofness of PVC skirtings.

Easy assembly and dirt resistance. Thanks to the additional flexible and integrated seals, we have solid waterproof barrier on two sides - the wall and the floor.

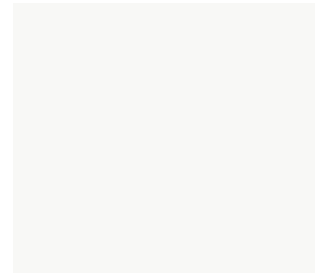

01 / WHITE  
RAL 9003



03 / DARK GREY  
RAL 7042

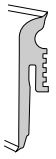
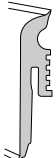

		HEIGHT	WIDTH	LENGTH	100% WATERPROOF	GLUE INSTALLATION	CLIPS INSTALLATION
VIGO 60		60 mm	15 mm	220 cm	✓	✓	✓
VIGO 80		80 mm	15 mm	220 cm	✓	✓	✓

# UNDERLAYS



## \_MULTIPROTEC VINYL CLICK

Special needs require special solutions. For areas with high level of traffic. Floors with click system require an underlay with high value of Compressive Strength. This is exactly what you can expect from our products. If the underfloor will be used do not worry you are covered – our products also perform well with underfloor heating thanks to the low value of thermal resistance. Additionally, Multiprotec products **have a Bfl-S1 fire class Bfl-S1 fire class.**

## \_SECURA VINYL CLICK

Products dedicated for vinyl floors with click system. Suitable for areas with high traffic level. High CS value improves the quality of the system and increases the durability of the floor. This product is very easy to install and align thanks to accordion form and cutting lines. High IS value - **(IS = 19dB)** for this XPS products allows for implementation in commercial areas where special parameters are required.



## \_MULTIPROTEC LVT FASTLAY HD

Underlay ideal for dryback floors. It can be used for quick renovation without interference in subsoil. Minimum subsoil preparation (eliminates minor unevenness) and much quicker glue assembly. Innovative self-adhesive layer allows corrections up to 10 minutes after floor installation. You do not need experience in fitting a to install the dryback floor on our fastlay mate. It is as easy as the click system. It is an ideal solution for do-it-yourself enthusiasts as well as for professionals thanks to high CS (500kPa) and DL (500 000 cycles) parameters.





www.blauer-engel.de/ut55



### MULTIPROTEC VINYL CLICK

### SECURA VINYL CLICK

### MULTIPROTEC LVT FASTLAY HD

DEDICATED FOR:  
AMARON AND LIBERAL

DEDICATED FOR:  
AMARON AND LIBERAL

DEDICATED FOR:  
ARQ

PUM/PET
1,4 mm
Roll

XPS/PET
1,5 mm
Smart

PUM/PET
1,8 mm
Roll



CLASS PC2 (<1,2 mm)
CLASS CS3 (<400 kPa)
CLASS DL3 (>400 000 CYCLES)
CLASS RLB3 (≤1500 mm)
<16 dB
yes
<0,008 m <sup>2</sup> K/W
>75 m

CLASS PC2 (<1,0 mm)
CLASS CS3 (<400 kPa)
CLASS DL3 (>400 000 CYCLES)
CLASS RLB3 (≤1500 mm)
<19 dB
yes
<0,04 m <sup>2</sup> K/W
>150 m

CLASS PC2 (<1,3 mm)
CLASS CS3 (<500 kPa)
CLASS DL3 (>500 000 CYCLES)
CLASS RLB3 (≤1500 mm)
<17 dB
yes
<0,01 m <sup>2</sup> K/W
>75 m

EAN 5905167776339

EAN 5905167816943

EAN 5905167816967





# FLOOR PROFILES

## PRO SYSTEM

This offer is for the most demanding customers. If you are looking for a professional solution at its best style. The PRO SYSTEM offer includes precise and elegant solutions of the most common problems. In PRO SYSTEM you will find the perfect masking up to 10 mm LVT / RIGID dilatation or an aesthetic connection of a hard floor with a carpet.



B1



B3

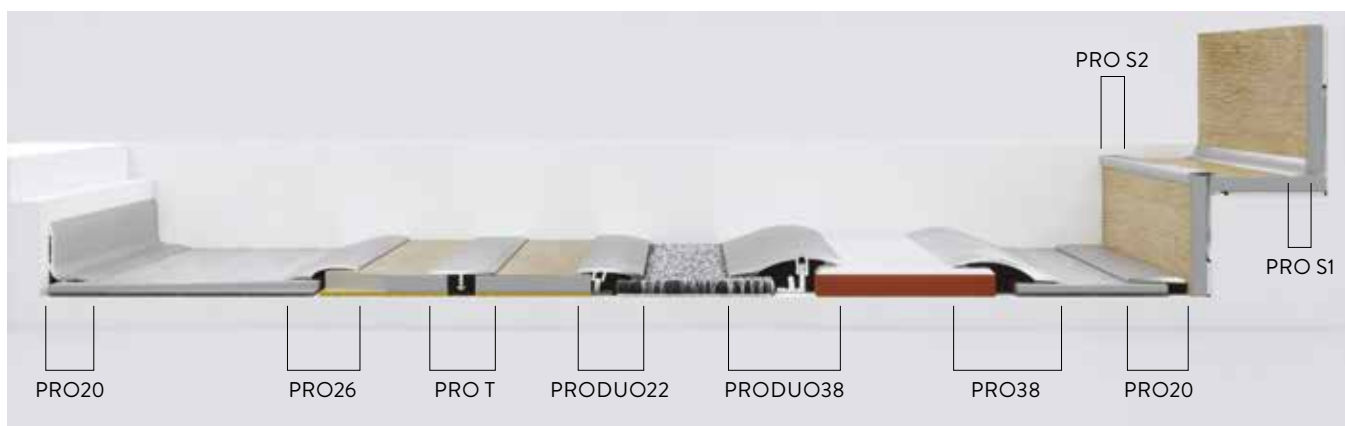

	WIDTH	ANODE	SCREW FIX	GLUE FIX	MAX DILATATION	MAX LEVELING
PRO20	20 m	+	-	+	10 mm	-
PRO T	22 m	+	-	+	16 mm	-
PRODUO22	22 m	+	+	+	16 mm	-
PRO26	26 m	+	-	+	10 mm	6 m
PRO38	38 m	+	-	+	32 mm	16 m
PRODUO38	38 m	+	+	+	32 mm	16 m
PRO L	15/20 mm	+	-	+	15 mm	-
PRO S1	12/4,5 mm	-	-	+	-	-
PRO S2	5,5 mm	-	-	+	-	-

# STAIRS SOLUTION FOR CLICK FLOOR



The same floor throughout the house, in the rooms, in the kitchen and even on the stairs. Thanks to the Arbiton stair profile system, you can finish your stairs using panels from the Amaron and Liberal collections. Using the same click panels, you can finish both treads and risers. In this case, the panels are glued to the floor. The profiles have been designed in an

aesthetic and minimalistic way. Finishing the stairs with the use of Arbiton profiles is as complicated as laying the click floor. It is faster than standard solutions and does not require a specialized team. Profiles are sold in an universal 2m length, which allows you to cut them to the desired size and use in almost any investment.

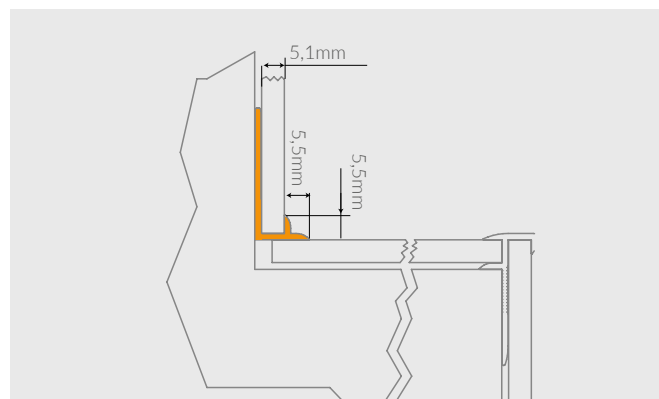
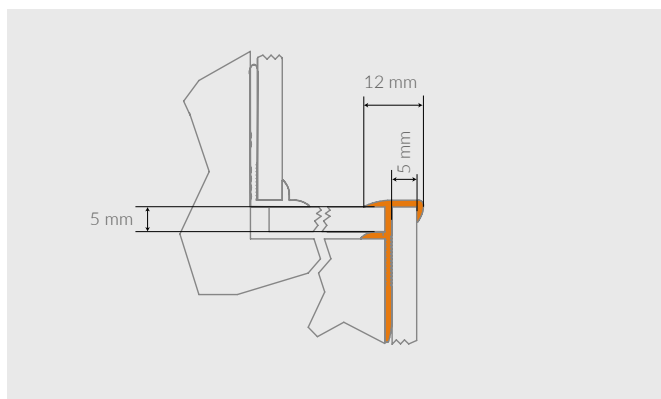

# EAN CODES

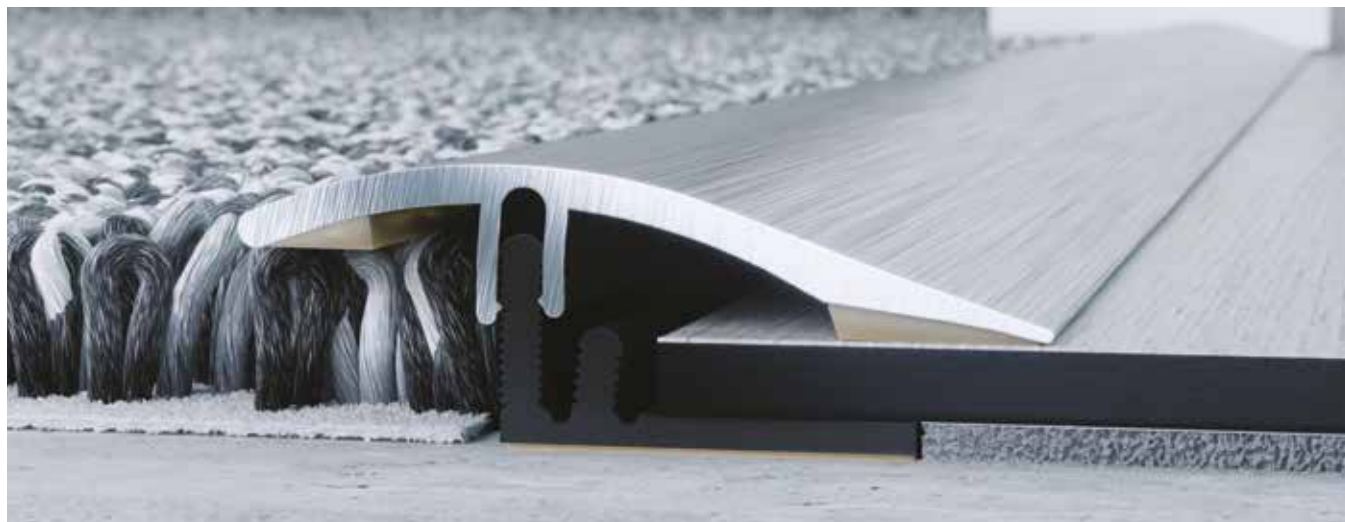

PROFILES	LENGTH	COLOR B1	COLOR B3
PRO20	0,93 m	5905167800911	5905167800935
PRO20	1,86 m	5905167800942	5905167800966
PRO T	0,93 m	5905167815458	5905167815465
PRO T	1,86 m	5905167815472	5905167815489
PRODUO22	0,93 m	5905167815106	5905167815113
PRODUO22	1,86 m	5905167815120	5905167815137
PRO26	0,93 m	5905167800973	5905167800997
PRO26	1,86 m	5905167801000	5905167801024
PRO38	0,93 m	5905167825020	5905167825037
PRO38	1,86 m	5905167825044	5905167825051
PRODUO38	0,93 m	5905167815144	5905167815151
PRODUO38	1,86 m	5905167801109	5905167815168
PRO L	0,93 m	5905167801048	5905167801062
PRO L	1,86 m	5905167801031	5905167801055
PRO S1	2,00 m	5905167839287	5905167839300
PRO S2	2,00 m	5905167839270	5905167839294

SKIRTING BOARDS	WHITE	DARK GREY	GREY	ANTHRACITE
VIGO 80	5905167826478	5905167826492	-	-
VIGO 60	5905167825679	5905167800942	5905167825686	5905167825709

UNDERLAYS	MATERIAL	THICKNESS	FORM	EAN
MULTIPROTEC VINYL CLICK	PUM/PET	1,4	ROLL	5905167776339
SECURA VINYL CLICK	XPS/PET	1,5	SMART	5905167816943
MULTIPROTEC LVT FASTLAY HD	PUM/PET	1,8	ROLL	5905167816967

# EAN CODES

FLOOR COLLECTION	COLOR NR	COLOR NAME	FLOOR EAN	TORE 60 COLOR	TORE 60 EAN	
AMARON HERRINGBONE	CA 158	HARLOW OAK	5905167826676	158	5905167835746	
	CA 159	WEMBLEY OAK	5905167826683	159	5905167835753	
	CA 153	YANKEE OAK	5905167839324	153	5905167835692	
	CA 147	GEORGETOWN OAK	5905167839331	147	5905167835630	
	CA 167	PRESTON OAK	5905167839348	167	5905167839430	
AMARON SUPERIORE	CA 168	GAILLARDE OAK	5905167839355	168	5905167843161	
	CA 169	WEISSHORN OAK	5905167839362	169	5905167843178	
	CA 170	PATENDORF OAK	5905167839379	170	5905167843185	
	CA 171	STAMBERGER OAK	5905167839386	171	5905167843192	
AMARON WOOD DESIGN	CA 102	ALASKAN OAK	5905167798508	102	5905167835388	
	CA 115	OREGON OAK	5905167798539	115	5905167835517	
	CA 116	ARGOS OAK	5905167798546	116	5905167835524	
	CA 117	LAHTI OAK	5905167798553	117	5905167835531	
	CA 113	PANAMA OAK	5905167798515	113	5905167835494	
	CA 145	WELLINGTON OAK	5905167814871	145	5905167835616	
	CA 146	BELFORD OAK	5905167814888	146	5905167835623	
	CA 114	WILIAMSBURG OAK	5905167798522	114	5905167835616	
	CA 147	GEORGETOWN OAK	5905167814895	147	5905167835630	
	CA 148	GRANTS OAK	5905167814901	148	5905167835647	
	CA 153	YANKEE OAK	5905167824191	153	5905167835692	
	CA 154	SIERRA OAK	5905167824207	154	5905167835708	
	CA 155	MAYNE OAK	5905167824214	155	5905167835715	
	AMARON XXL STONE DESIGN	CA 149	GLACIER CONCRETE	5905167814918	149	5905167835654
		CA 150	TOKIO CONCRETE	5905167814925	150	5905167835661
CA 151		BAKER CONCRETE	5905167814932	151	5905167835678	
CA 152		HAMBURG CONCRETE	5905167814949	152	5905167835685	
LIBERAL	CL 102	ALASKAN OAK	5905167798393	102	5905167835388	
	CL 104	CANADIAN OAK	5905167798416	104	5905167835401	
	CL 105	CONEY OAK	5905167798423	105	5905167835418	
	CL 112	BOLOGNA OAK	5905167798492	112	5905167835487	
	CL 106	PORTLAND OAK	5905167798430	106	5905167836941	
	CL 107	PASADENA OAK	5905167798447	107	5905167836934	
	CL 108	DAKOTA OAK	5905167798454	108	5905167835449	
	CL 109	GEORGIA OAK	5905167798461	109	5905167835456	
	CL 110	YAKIMA OAK	5905167798478	110	5905167825679	
	CL 111	NEVADA WALNUT	5905167798485	111	5905167835470	
	CL 157	RIDGEFIELD OAK	5905167824238	-	-	
CL 156	LEONARD OAK	5905167824221	-	-		
AROQ WOOD DESIGN	DA 103	BERGEN OAK	5905167798621	103	5905167835395	
	DA 112	BOLOGNA OAK	5905167798638	112	5905167835487	
	DA 107	PASADENA OAK	5905167798645	107	5905167836934	
	DA 114	WILIAMSBURG OAK	5905167798652	114	5905167835500	
	DA 111	NEVADA WALNUT	5905167798669	111	5905167835470	
	DA 124	CAMDEN OAK	5905167798676	124	5905167835609	
AROQ STONE DESIGN	DA 118	SOHO CONCRETE	5905167798560	118	5905167835548	
	DA 119	TORONTO CONCRETE	5905167798584	119	5905167835555	
	DA 120	MIAMI CONCRETE	5905167798591	120	5905167835562	
	DA 121	BROOKLYN CONCRETE	5905167798607	121	5905167835579	
	DA 122	BROADWAY CONCRETE	5905167798614	122	5905167835586	
	DA 123	MANHATTAN CONCRETE	5905167798577	123	5905167835593	

TORE 80 COLOR	TORE 80 EAN
158	5905167836132
159	5905167836149
153	5905167836088
147	5905167836026
167	5905167839447
168	5905167843208
169	5905167843215
170	5905167843222
171	5905167843239
102	5905167835777
115	5905167835906
116	5905167835913
117	5905167835920
113	5905167835883
145	5905167836002
146	5905167836019
114	5905167836002
147	5905167836026
148	5905167836033
153	5905167836088
154	5905167836095
155	5905167836101
149	5905167836040
150	5905167836057
151	5905167836064
152	5905167836071
102	5905167835777
104	5905167835791
105	5905167835807
112	5905167835876
106	5905167835814
107	5905167835821
108	5905167835838
109	5905167835845
110	5905167835852
111	5905167835869
-	-
-	-
103	5905167835784
112	5905167835876
107	5905167835821
114	5905167835890
111	5905167835869
124	5905167835999
118	5905167835937
119	5905167835944
120	5905167835951
121	5905167835968
122	5905167835975
123	5905167835982



LEONARD OAK  
CL156

# TECHNICAL PARAMETERS

COLLECTION	DIMENSIONS	THICKNESS / WEAR LAYER	PACK	
<b>AMARON HERRINGBONE</b>	 592 mm x 148 mm		1 BOX =  8 x L 8 x R 1,402 m <sup>2</sup>	100,944 m <sup>2</sup>
<b>AMARON SUPERIORE</b>	 1830 x 229 mm		1 BOX = 5  2,095 m <sup>2</sup>	108,94 m <sup>2</sup>
<b>AMARON WOOD DESIGN</b>	 1511 x 229 mm		1 BOX = 6  2,076 m <sup>2</sup>	116,256 m <sup>2</sup>
<b>AMARON XXL STONE DESIGN</b>	 914 x 457 mm		1 BOX = 5  2,088 m <sup>2</sup>	100,224 m <sup>2</sup>
<b>LIBERAL</b>	 1220 x 229 mm		1 BOX = 8  2,235 m <sup>2</sup>	143,04 m <sup>2</sup>
<b>AROQ WOOD DESIGN</b>	 914 x 152 mm		1 BOX = 20  2,779 m <sup>2</sup>	200,088 m <sup>2</sup>
<b>AROQ STONE DESIGN</b>	 610 x 305 mm		1 BOX = 20  3,721 m <sup>2</sup>	208,376 m <sup>2</sup>

PERFORMANCE LEVEL

RESIDENTIAL  
GUARANTEE

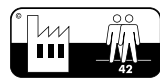
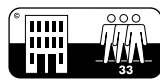
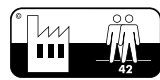
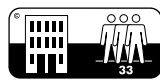
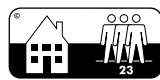
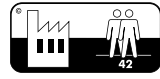
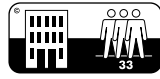
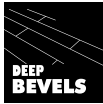
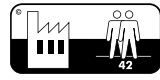
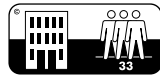
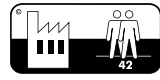
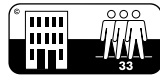
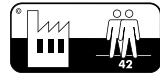



**Arbiton**  
FLOOR EXPERT

The catalogue is a free of charge presentation of products of Decora S.A. and acc. to valid law it is not a commercial offer.

Colors and textures of the products in pictures may differ from real ones because of limited printing technologies. Decora S.A. reserves its right to alter availability of the products on some markets and at some distributors. The products included in the catalogues do not pose a complete offer of Decora S.A.

**DECORA GROUP**

Decora S.A., ul. Prądyńskiego 24a  
63-000 Środa Wlkp., Polska  
tel.: +48 61 28 64 200  
fax: +48 61 28 54 975  
e-mail: sales@decora.pl  
www.arbiton.com

**GERMANY**

ewifoam E. Wicklein GmbH  
Stockumer Str. 28  
58453 Witten  
Tel.: +49 (0) 9261 50 490-0  
Fax.: +49 (0) 9261 50 490-50  
info@ewifoam.de  
www.ewifoam.de