

Przewody kominowe typu **DWWŻ**

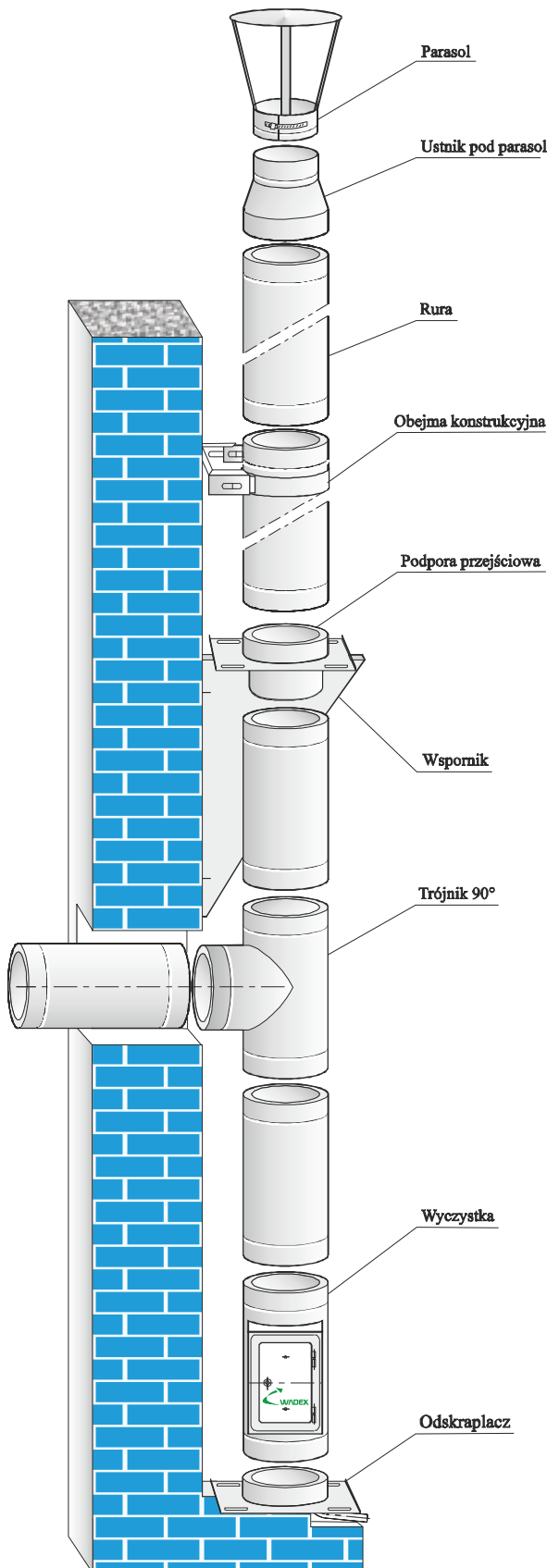

PRZEZNACZENIE:

stosowany jako komin zewnętrzny w celu odprowadzenia spalin na zewnątrz budynku z urządzeń grzewczych opalanych drewnem lub ekologicznymi paliwami stałymi o maksymalnej temperaturze spalin 600 °C - przewód spalinowy jest wykonany z blachy zaliczanej do żaroodpornych o grubości 1 mm

BUDOWA RUR I KSZTAŁTEK:

elementy dwuścienne izolowane wełną ceramiczną o grubości 50 mm,

ZAKRES ŚREDNIC:

130/225 ÷ 400/500 mm

PALIWO:

drewno lub ekologiczne paliwa stałe

GATUNEK I GRUBOŚĆ MATERIAŁU:

stal zaliczana do grupy żaroodpornych o grubości 1 mm – stal 1.4301

ODPORNOŚĆ NA KOROZJĘ:

Vm/ V3

ODPORNOŚĆ NA POŻAR SADZY:

Odporny

ODLEGŁOŚĆ OD MATERIAŁÓW PALNYCH:

50 mm

KLASA TEMPERATURY:

T 600 - 600 °C

SPOSÓB PRACY KOMINA:

podciśnieniowy

ODPORNOŚĆ NA DZIAŁANIE KONDENSATU:

D

Uwaga: elementy wsporcze, konstrukcyjne i osłonowe z systemu DWW

USTNIK

450

d	D	INDEX
130	225	450130000
150	250	450150000
160	250	450160000
180	270	450180000
200	300	450200000
250	350	450250000
300	400	450300000
350	450	450350000
400	500	450400000

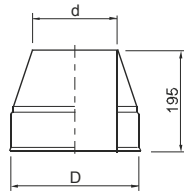

USTNIK POD PARASOL

451

d	D	INDEX
130	225	451130000
150	250	451150000
160	250	451160000
180	270	451180000
200	300	451200000
250	350	451250000
300	400	451300000
350	450	451350000
400	500	451400000

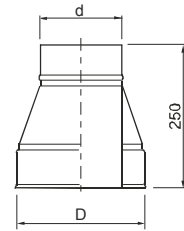

RURA

453, 454, 456

INDEX					
d	D	L 1000	L 500	L 250	
130	225	453130000	454130000	456130000	
150	250	453150000	454150000	456150000	
160	250	453160000	454160000	456160000	
180	270	453180000	454180000	456180000	
200	300	453200000	454200000	456200000	
250	350	453250000	454250000	456250000	
300	400	453300000	454300000	456300000	
350	450	453350000	454350000	456350000	
400	500	453400000	454400000	456400000	

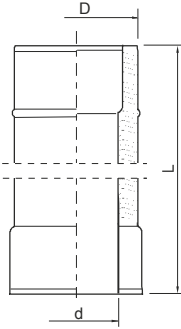

TRÓJNIK 90°

457

d	D	L	INDEX
130	225	450	457130000
150	250	450	457150000
160	250	450	457160000
180	270	500	457180000
200	300	500	457200000
250	350	550	457250000
300	400	600	457300000
350	450	650	457350000
400	500	700	457400000

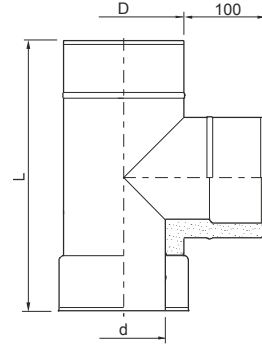

TRÓJNIK 45°

480

d	D	A	L	INDEX
130	225	350	530	480130000
150	250	400	570	480150000
160	250	400	570	480160000
180	270	410	570	480180000
200	300	500	700	480200000
250	350	550	800	480250000
300	400	600	800	480300000
350	450	680	900	480350000
400	500	780	1000	480400000

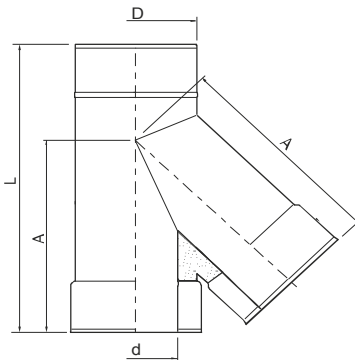

KOLANO 45°

465

d	D	A	INDEX
130	225	140	465130000
150	250	160	465150000
160	250	160	465160000
180	270	155	465180000
200	300	195	465200000
250	350	205	465250000
300	400	215	465300000
350	450	240	465350000
400	500	240	465400000

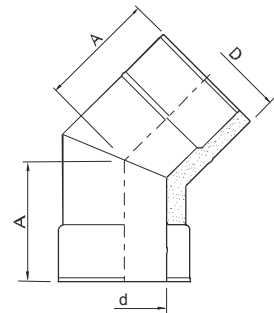

WYCZYSTKA

461

d	D	INDEX
130	225	461130000
150	250	461150000
160	250	461160000
180	270	461180000
200	300	461200000
250	350	461250000
300	400	461300000
350	450	461350000
400	500	461400000

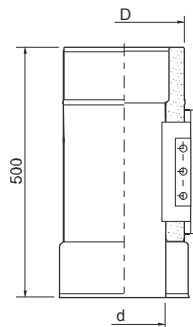

KOLANO 93°

466

d	D	A	INDEX
130	225	200	466130000
150	250	200	466150000
160	250	200	466160000
180	270	200	466180000
200	300	210	466200000
250	350	255	466250000
300	400	295	466300000
350	450	300	466350000
400	500	340	466400000

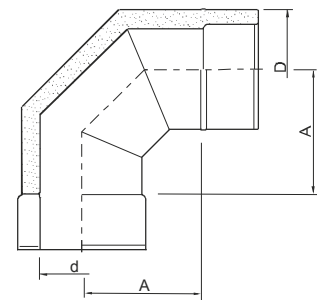

PODPORA PRZEJŚCIOWA

462

d	D	A	INDEX
130	225	300	462130000
150	250	350	462150000
160	250	350	462160000
180	270	350	462180000
200	300	400	462200000
250	350	450	462250000
300	400	500	462300000
350	450	550	462350000
400	500	600	462400000

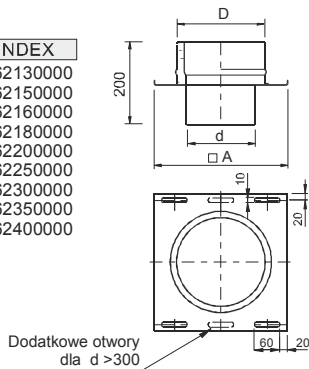

ODSKRAPLACZ

464

d	D	A	INDEX
130	225	300	464130000
150	250	350	464150000
160	250	350	464160000
180	270	400	464180000
200	300	400	464200000
250	350	450	464250000
300	400	500	464300000
350	450	550	464350000
400	500	600	464400000

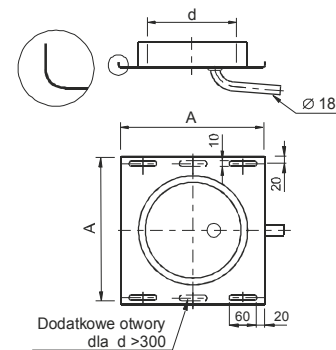

ZAKOŃCZENIE NYPEL - KIELICH 471

d	D	INDEX
130	225	471130000
150	250	471150000
160	250	471160000
180	270	471180000
200	300	471200000
250	350	471250000
300	400	471300000
350	450	471350000
400	500	471400000

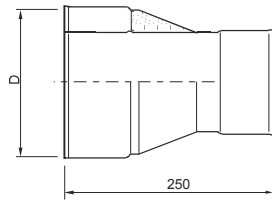

REDUKCJA ODWROTNA 476

d	D	INDEX
130	225	476130xzy
150	250	476150xzy
160	250	476160xyz
180	270	476180xzy
200	300	476200xzy
250	350	476250xzy
300	400	476300xzy
350	450	476350xzy
400	500	476400xzy

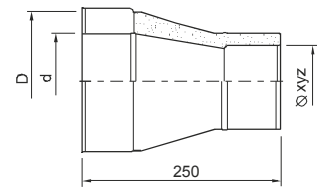

ZAKOŃCZENIE NYPEL - NYPEL 474

d	D	INDEX
130	225	474130000
150	250	474150000
160	250	474160000
180	270	474180000
200	300	474200000
250	350	474250000
300	400	474300000
350	450	474350000
400	500	474400000

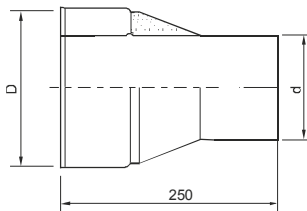

ZAKOŃCZENIE KIELICH - KIELICH 477

d	D	INDEX
130	225	477130000
150	250	477150000
160	250	477160000
180	270	477180000
200	300	477200000
250	350	477250000
300	400	477300000
350	450	477350000
400	500	477400000

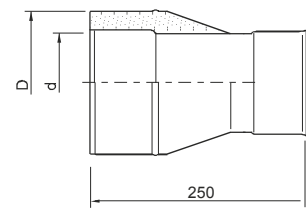

REDUKCJA 475

d	D	INDEX
130	225	475130xzy
150	250	475150xzy
160	250	475160xyz
180	270	475180xzy
200	300	475200xzy
250	350	475250xzy
300	400	475300xzy
350	450	475350xzy
400	500	475400xzy

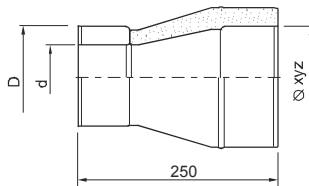

ZAKOŃCZENIE KIELICH - NYPEL 478

d	D	INDEX
130	225	478130000
150	250	478150000
160	250	478160000
180	270	478180000
200	300	478200000
250	350	478250000
300	400	478300000
350	450	478350000
400	500	478400000

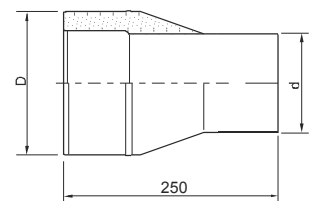

PRZEDŁUŻKA do komina 463

d	D	A	L	INDEX	
130	225	320	1280	780	463130000
150	250	320	1280	780	463150000
160	250	320	1280	780	463160000
180	270	320	1280	780	463180000
200	300	400	1280	780	463200000
250	350	450	1280	780	463250000

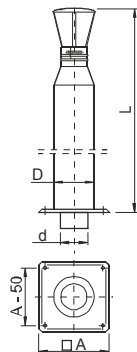

Dla L=1280 indeks jest np.. 463 130 000
a dla L=780 indeks jest 463 130 100

KOLANO Z WYCZYSTKĄ OKRĄGLĄ 452

d1	d	D	A	INDEX
130	130	225	200	452130000
	150	250	200	452150000
160	160	250	205	452160000
	180	270	205	452180000
200	200	300	215	452200000
	250	350	255	452250000
300	300	400	295	452300000
	350	450	300	452350000
400	500	340	452400000	

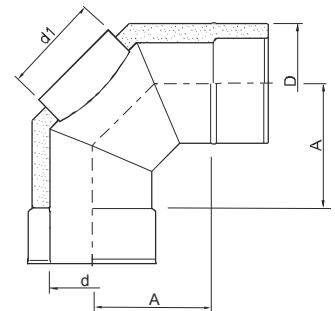

KOLANO 60° 473

d	D	A	INDEX
130	225	140	473130000
150	250	160	473150000
160	250	160	473160000
180	270	170	473180000
200	300	195	473200000
250	350	205	473250000
300	400	215	473300000
350	450	240	473350000
400	500	240	473400000

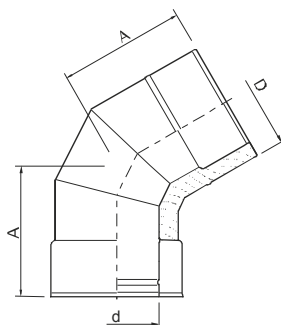

KOLANO 30° 472

d	D	A	INDEX
130	225	140	472130000
150	250	160	472150000
160	250	160	472160000
180	270	155	472180000
200	300	195	472200000
250	350	205	472250000
300	400	215	472300000
350	450	240	472350000
400	500	240	472400000

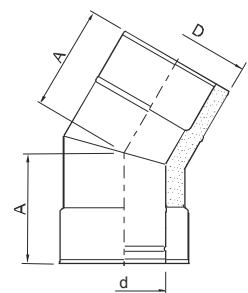

KOLANO 15°

484

d	D	A	INDEX
130	225	140	484130000
150	250	160	484150000
160	250	160	484160000
180	270	155	484180000
200	300	195	484200000
250	350	205	484250000
300	400	215	484300000
350	450	240	484350000
400	500	240	484400000

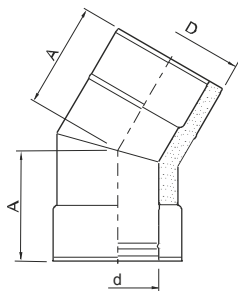

TRÓJNIK 90° Z WYCZYSTKĄ

483

d	D	L	INDEX
130	225	500	483130000
150	250	500	483150000
160	250	500	483160000
180	270	500	483180000
200	300	500	483200000
250	350	550	483250000
300	400	600	483300000
350	450	650	483350000
400	500	700	483400000

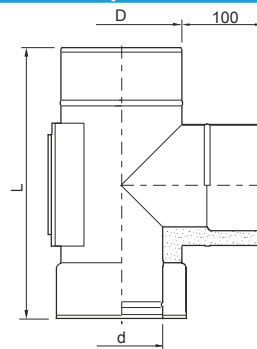

TRÓJNIK REDUKCYJNY 90°

459

d	D	d1	L	INDEX
130	225	400	459130xyz	
150	250	450	459150xyz	
160	250	450	459160xyz	
180	270	450	459180xyz	
200	300	500	459200xyz	
250	350	550	459250xyz	
300	400	600	459300xyz	
350	450	650	459350xyz	
400	500	700	459400xyz	

Zgodnie z zamówieniem

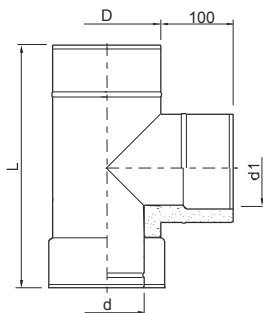

TRÓJNIK 45° z WYCZYSTKĄ

479

d	D	A	L	INDEX
130	225	350	500	479130000
150	250	400	570	479150000
160	250	400	570	479160000
180	270	410	570	479180000
200	300	500	700	479200000
250	350	550	800	479250000
300	400	600	800	479300000
350	450	680	900	479350000
400	500	780	1000	479400000

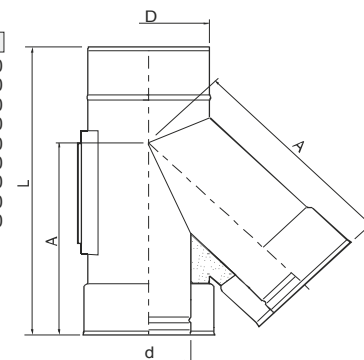

TRÓJNIK REDUKCYJNY 45°

460

d	D	d1	A	L	INDEX
130	225	350	500	460130xyz	
150	250	400	570	460150xyz	
160	250	400	570	460160xyz	
180	270	410	570	460180xyz	
200	300	500	700	460200xyz	
250	350	550	800	460250xyz	
300	400	600	800	460300xyz	
350	450	680	900	460350xyz	
400	500	780	1000	460400xyz	

Zgodnie z zamówieniem

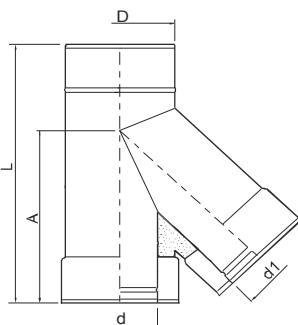

REDUKCJA DWUNYPLOWA

482

d	D	INDEX
130	225	482130xyz
150	250	482150xyz
160	250	482160xyz
180	270	482180xyz
200	300	482200xyz
250	350	482250xyz
300	400	482300xyz
350	450	482350xyz
400	500	482400xyz

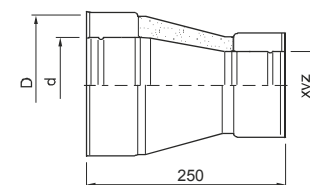

REDUKCJA DWUKIELICHOWA

481

d	D	INDEX
130	225	481130xyz
150	250	481150xyz
160	250	481160xyz
180	270	481180xyz
200	300	481200xyz
250	350	481250xyz
300	400	481300xyz
350	450	481350xyz
400	500	481400xyz

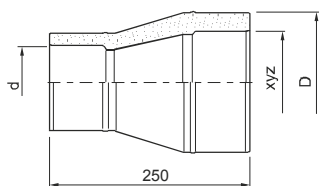

USTNIK POD NASADĘ KOMINOWĄ

451

d	D	INDEX
130	225	451130100
150	250	451150100
160	250	451160100
180	270	451180100
200	300	451200100
250	350	451250100
300	400	451300100
350	450	451350100
400	500	451400100

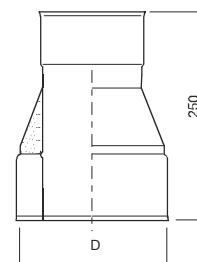

ZAKOŃCZENIE REDUKCYJNE KIELICH-NYPEL 485

d	D	INDEX
130	225	485130xyz5
150	250	485150xyz5
160	250	485160xyz5
180	270	485180xyz5
200	300	485200xyz5
250	350	485250xyz5
300	400	485300xyz5
350	450	485350xyz5
400	500	485400xyz5

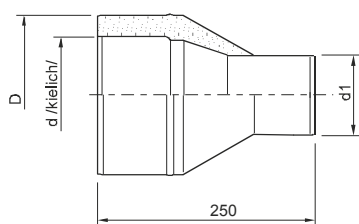

xyz /d1/ - średnica zgodnie z zamówieniem

ZAKOŃCZENIE REDUKCYJNE NYPEL-NYPEL 487

d	D	INDEX
130	225	487130xyz5
150	250	487150xyz5
160	250	487160xyz5
180	270	487180xyz5
200	300	487200xyz5
250	350	487250xyz5
300	400	487300xyz5
350	450	487350xyz5
400	500	487400xyz5

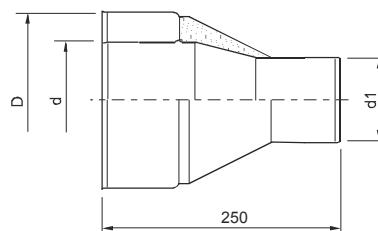

xyz /d1/ - średnica zgodnie z zamówieniem

ZAKOŃCZENIE REDUKCYJNE KIELICH-KIELICH 486

d	D	INDEX
130	225	486130xyz5
150	250	486150xyz5
160	250	486160xyz5
180	270	486180xyz5
200	300	486200xyz5
250	350	486250xyz5
300	400	486300xyz5
350	450	486350xyz5
400	500	486400xyz5

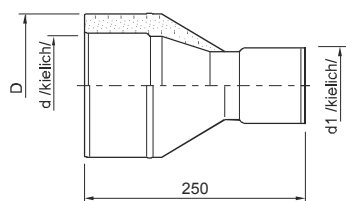

xyz /d1/ - średnica zgodnie z zamówieniem

ZAKOŃCZENIE REDUKCYJNE NYPEL-KIELICH 488

d	D	INDEX
130	225	488130xyz5
150	250	488150xyz5
160	250	488160xyz5
180	270	488180xyz5
200	300	488200xyz5
250	350	488250xyz5
300	400	488300xyz5
350	450	488350xyz5
400	500	488400xyz5

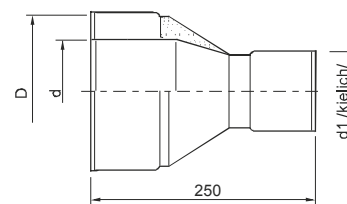

xyz /d1/ - średnica zgodnie z zamówieniem

ELEMENT NIETYPOWY

999

Elementy niekatalogowe wykonywane są na podstawie rysunków dostarczonych przez klienta. Wycena takich elementów jest oparta na indywidualnej kalkulacji.

PRZEZNACZENIE:

stosowany jako komin zewnętrzny w celu odprowadzenia spalin na zewnątrz budynku z urządzeń grzewczych opalanych drewnem lub ekologicznymi paliwami stałymi o maksymalnej temperaturze spalin 600 °C; przewód spalinowy jest wykonany z blachy zaliczanej do żaroodpornych o grubości 1 mm

BUDOWA RUR I KSZTAŁTEK:

elementy dwuścienne izolowane wełną ceramiczną o grubości 25 mm,

ZAKRES ŚREDNIC:

130/180 ÷ 400/450 mm

PALIWO:

drewno lub ekologiczne paliwa stałe

GATUNEK I GRUBOŚĆ MATERIAŁU:

stal zaliczana do grupy żaroodpornych o grubości 1 mm – stal 1.4301

ODPORNOŚĆ NA KOROZJĘ:

Vm/V3

ODLEGŁOŚĆ OD MATERIAŁÓW PALNYCH:

150 mm

KLASA TEMPERATURY:

T 600 - 600 °C

SPOSÓB PRACY KOMINA:

podciśnieniowy

ODPORNOŚĆ NADZIAŁANIE KONDENSATU:

D

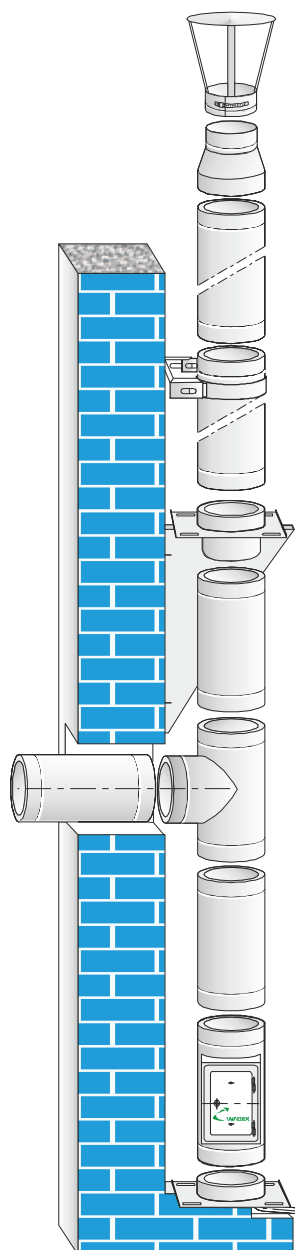

USTNIK invest
450

d	D	INDEX
130	180	4501300007
150	200	4501500007
160	200	4501600007
180	225	4501800007
200	250	4502000007
250	300	4502500007
300	350	4503000007
350	400	4503500007
400	450	4504000007

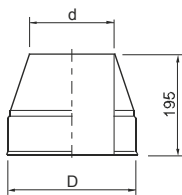
USTNIK POD PARASOL invest
451

d	D	INDEX
130	180	4511300007
150	200	4511500007
160	200	4511600007
180	225	4511800007
200	250	4512000007
250	300	4512500007
300	350	4513000007
350	400	4513500007
400	450	4514000007

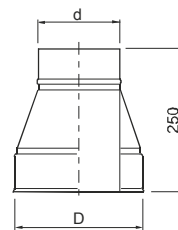
RURA invest
453, 454, 456

INDEX				
d	D	L 1000	L 500	L 250
130	180	4531300007	4541300007	4561300007
150	200	4531500007	4541500007	4561500007
160	200	4531600007	4541600007	4561600007
180	225	4531800007	4541800007	4561800007
200	250	4532000007	4542000007	4562000007
250	300	4532500007	4542500007	4562500007
300	350	4533000007	4543000007	4563000007
350	400	4533500007	4543500007	4563500007
400	450	4534000007	4544000007	4564000007

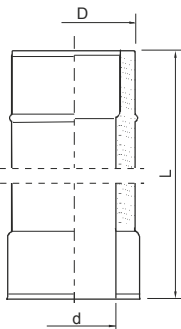
TRÓJNIK 90° invest
457

d	D	L	INDEX
130	180	400	4571300007
150	200	400	4571500007
160	200	400	4571600007
180	225	450	4571800007
200	250	450	4572000007
250	300	500	4572500007
300	350	550	4573000007
350	400	600	4573500007
400	450	650	4574000007

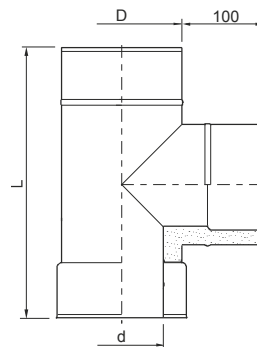
TRÓJNIK 45° invest
480

d	D	A	L	INDEX
130	180	350	500	4801300007
150	200	350	500	4801500007
160	200	350	500	4801600007
180	225	400	570	4801800007
200	250	400	570	4802000007
250	300	500	700	4802500007
300	350	550	800	4803000007
350	400	600	800	4803500007
400	450	680	900	4804000007

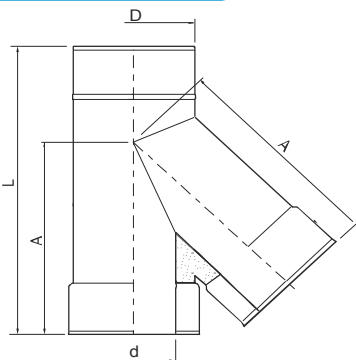
KOLANO 45° invest
465

d	D	A	INDEX
130	180	130	4651300007
150	200	135	4651500007
160	200	135	4651600007
180	225	140	4651800007
200	250	160	4652000007
250	300	195	4652500007
300	350	205	4653000007
350	400	215	4653500007
400	450	240	4654000007

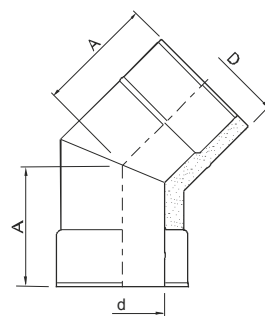
WYCZYSTKA invest
461

d	D	INDEX
130	180	4611300007
150	200	4611500007
160	200	4611600007
180	225	4611800007
200	250	4612000007
250	300	4612500007
300	350	4613000007
350	400	4613500007
400	450	4614000007

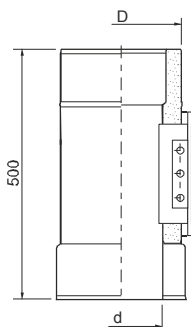
KOLANO 93° invest
466

d	D	A	INDEX
130	180	170	4661300007
150	200	180	4661500007
160	200	180	4661600007
180	225	200	4661800007
200	250	215	4662000007
250	300	230	4662500007
300	350	260	4663000007
350	400	300	4663500007
400	450	315	4664000007

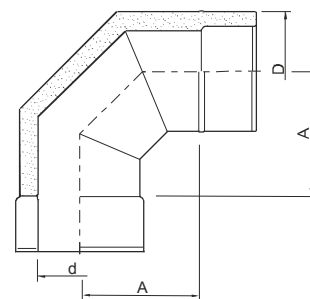
PODPORA PRZEJŚCIOWA invest
462

d	D	A	INDEX
130	180	300	4621300007
150	200	300	4621500007
160	200	300	4621600007
180	225	350	4621800007
200	250	350	4622000007
250	300	400	4622500007
300	350	450	4623000007
350	400	500	4623500007
400	450	550	4624000007

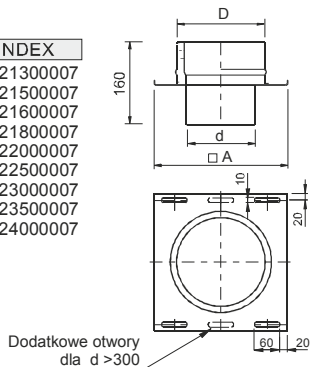

ODSKRAPLACZ invest
464

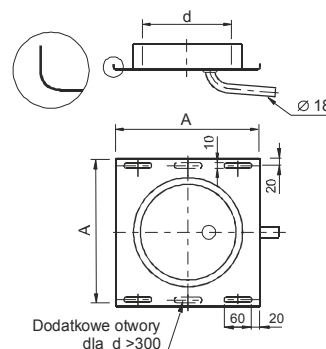
d	D	A	INDEX
130	180	300	4641300007
150	200	300	4641500007
160	200	300	4641600007
180	225	350	4641800007
200	250	350	4642000007
250	300	400	4642500007
300	350	450	4643000007
350	400	500	4643500007
400	450	550	4644000007

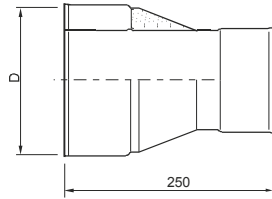

ZAKOŃCZENIE NYPEL-KIELICH invest 471

d	D	INDEX
130	180	4711300007
150	200	4711500007
160	200	4711600007
180	225	4711800007
200	250	4712000007
250	300	4712500007
300	350	4713000007
350	400	4713500007
400	450	4714000007



REDUKCJA ODWROTNA invest 476

d	D	INDEX
130	180	476130xzy7
150	200	476150xzy7
160	200	476160xzy7
180	225	476180xzy7
200	250	476200xzy7
250	300	476250xzy7
300	350	476300xzy7
350	400	476350xzy7
400	450	476400xzy7

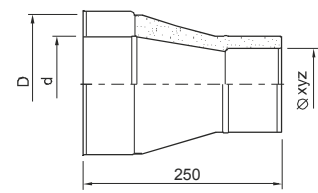

ZAKOŃCZENIE NYPEL-NYPEL invest 474

d	D	INDEX
130	180	4741300007
150	200	4741500007
160	200	4741600007
180	225	4741800007
200	250	4742000007
250	300	4742500007
300	350	4743000007
350	400	4743500007
400	450	4744000007

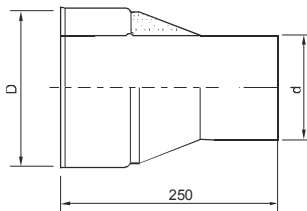

ZAKOŃCZENIE KIELICH-KIELICH invest 477

d	D	INDEX
130	180	4771300007
150	200	4771500007
160	200	4771600007
180	225	4771800007
200	250	4772000007
250	300	4772500007
300	350	4773000007
350	400	4773500007
400	450	4774000007

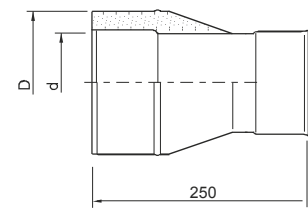

REDUKCJA invest 475

d	D	INDEX
130	180	475130xzy7
150	200	475150xzy7
160	200	475160xzy7
180	225	475180xzy7
200	250	475200xzy7
250	300	475250xzy7
300	350	475300xzy7
350	400	475350xzy7
400	450	475400xzy7

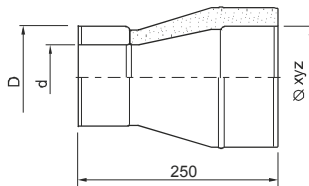

ZAKOŃCZENIE KIELICH-NYPEL invest 478

d	D	INDEX
130	180	4781300007
150	200	4781500007
160	200	4781600007
180	225	4781800007
200	250	4782000007
250	300	4782500007
300	350	4783000007
350	400	4783500007
400	450	4784000007

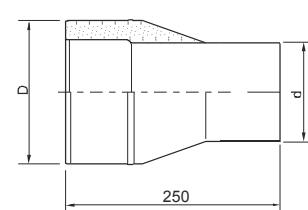

PRZEDŁUŻKA do komina invest 463

d	D	A	L	INDEX	
130	180	320	1280	780	4631300007
150	200	320	1280	780	4631500007
160	200	320	1280	780	4631600007
180	225	320	1280	780	4631800007
200	250	400	1280	780	4632000007
250	300	450	1280	780	4632500007

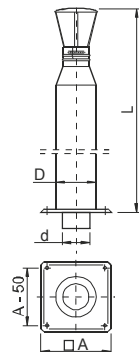

Dla L=1280 indeks jest np.. 463 130 0007
a dla L=780 indeks jest 463 130 1007

KOLANO Z WYCZYSTKĄ OKRĄGLĄ invest 452

d1	d	D	A	INDEX
130	130	180	180	4521300007
	150	200	180	4521500007
160	160	200	180	4521600007
	180	225	200	4521800007
200	200	250	215	4522000007
	250	300	230	4522500007
300	300	350	255	4523000007
	350	400	300	4523500007
400	450	315	4524000007	

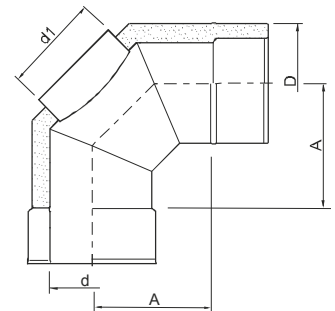

KOLANO 60° invest 473

d	D	A	INDEX
130	180	140	4731300007
150	200	145	4731500007
160	200	145	4731600007
180	225	160	4731800007
200	250	170	4732000007
250	300	195	4732500007
300	350	205	4733000007
350	400	215	4733500007
400	450	240	4734000007

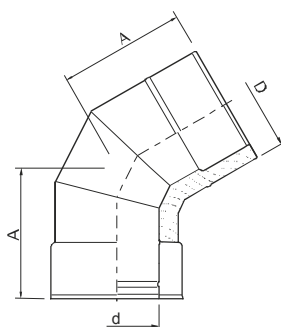

KOLANO 30° invest 472

d	D	A	INDEX
130	180	130	4721300007
150	200	135	4721500007
160	200	135	4721600007
180	225	140	4721800007
200	250	160	4722000007
250	300	195	4722500007
300	350	205	4723000007
350	400	215	4723500007
400	450	240	4724000007

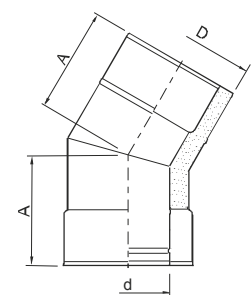

KOLANO 15° invest
484

d	D	A	INDEX
130	180	130	4841300007
150	200	135	4841500007
160	200	135	4841600007
180	225	140	4841800007
200	250	160	4842000007
250	300	195	4842500007
300	350	205	4843000007
350	400	215	4843500007
400	450	240	4844000007

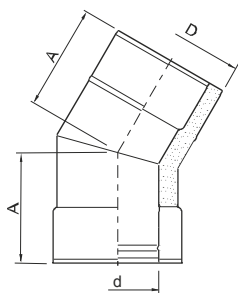
TRÓJNIK 90° z WYCZYSTKĄ invest
483

d	D	L	INDEX
130	180	500	4831300007
150	200	500	4831500007
160	200	500	4831600007
180	225	500	4831800007
200	250	500	4832000007
250	300	500	4832500007
300	350	550	4833000007
350	400	600	4833500007
400	450	650	4834000007

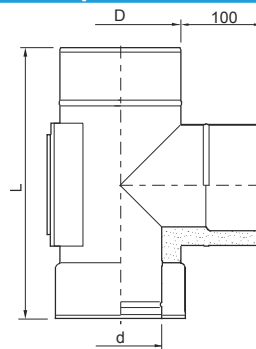
TRÓJNIK REDUKCYJNY 90° invest
459

d	D	INDEX
130	180	459130xyz7
150	200	459150xyz7
160	200	459160xyz7
180	225	459180xyz7
200	250	459200xyz7
250	300	459250xyz7
300	350	459300xyz7
350	400	459350xyz7
400	450	459400xyz7

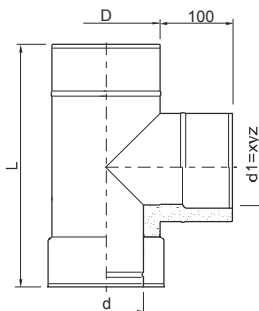

d1	130	150	160	180	200	250	300	350
D1	180	200	200	225	250	300	350	400
L		400		450		500	550	600

TRÓJNIK 45° z WYCZYSTKĄ invest
479

d	D	A	L	INDEX
130	180	350	500	4791300007
150	200	350	500	4791500007
160	200	350	500	4791600007
180	225	400	570	4791800007
200	250	400	570	4792000007
250	300	500	700	4792500007
300	350	550	800	4793000007
350	400	600	800	4793500007
400	450	680	900	4794000007

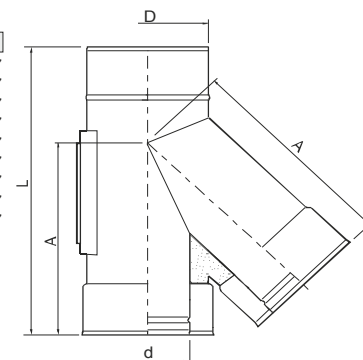
TRÓJNIK REDUKCYJNY 45° invest
460

d	D	INDEX
130	180	460130xyz7
150	200	460150xyz7
160	200	460160xyz7
180	225	460180xyz7
200	250	460200xyz7
250	300	460250xyz7
300	350	460300xyz7
350	400	460350xyz7
400	450	460400xyz7

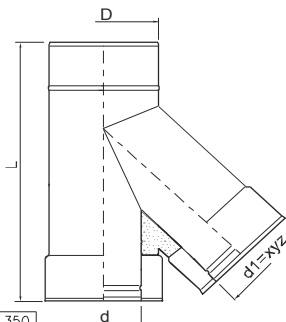

d1	130	150	160	180	200	250	300	350
D1	180	200	200	225	250	300	350	400
L		500		570		700	800	800

REDUKCJA DWUNYPOWA invest
482

d	D	INDEX
130	180	482130xyz7
150	200	482150xyz7
160	200	482160xyz7
180	225	482180xyz7
200	250	482200xyz7
250	300	482250xyz7
300	350	482300xyz7
350	400	482350xyz7
400	450	482400xyz7

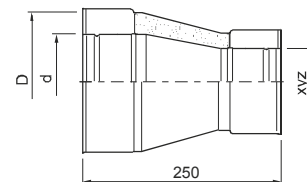
REDUKCJA DWUKIELICHOWA invest
481

d	D	INDEX
130	180	481130xyz7
150	200	481150xyz7
160	200	481160xyz7
180	225	481180xyz7
200	250	481200xyz7
250	300	481250xyz7
300	350	481300xyz7
350	400	481350xyz7
400	450	481400xyz7

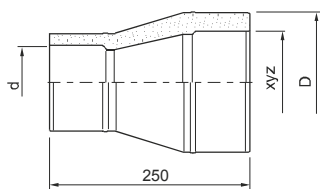

USTNIK POD NASADĘ KOMINOWĄ invest
451

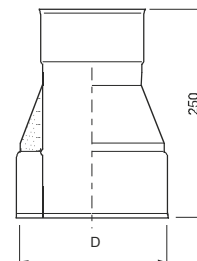
d	D	INDEX
130	180	4511301007
150	200	4511501007
160	200	4511601007
180	225	4511801007
200	250	4512001007
250	300	4512501007
300	350	4513001007
350	400	4513501007
400	450	4514001007

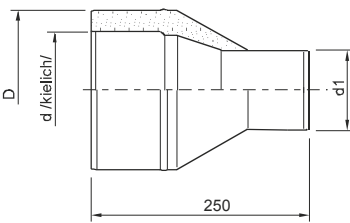

ZAKOŃCZENIE RED. KIELICH-NYPEL invest 485

d	D	INDEX
130	180	485130xyz7
150	200	485150xyz7
160	200	485160xyz7
180	225	485180xyz7
200	250	485200xyz7
250	300	485250xyz7
300	350	485300xyz7
350	400	485350xyz7
400	450	485400xyz7



xyz /d1/ - średnica zgodnie z zamówieniem

ZAKOŃCZENIE RED. NYPEL-NYPEL invest 487

d	D	INDEX
130	180	487130xyz7
150	200	487150xyz7
160	200	487160xyz7
180	225	487180xyz7
200	250	487200xyz7
250	300	487250xyz7
300	350	487300xyz7
350	400	487350xyz7
400	450	487400xyz7

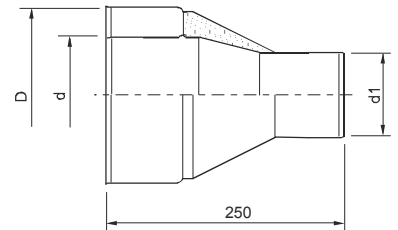

xyz /d1/ - średnica zgodnie z zamówieniem

ZAKOŃCZENIE RED. KIELICH-KIELICH invest 486

d	D	INDEX
130	180	486130xyz7
150	200	486150xyz7
160	200	486160xyz7
180	225	486180xyz7
200	250	486200xyz7
250	300	486250xyz7
300	350	486300xyz7
350	400	486350xyz7
400	450	486400xyz7

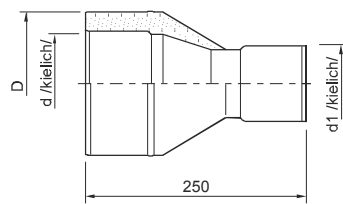

xyz /d1/ - średnica zgodnie z zamówieniem

ZAKOŃCZENIE RED. NYPEL-KIELICH invest 488

d	D	INDEX
130	180	488130xyz7
150	200	488150xyz7
160	200	488160xyz7
180	225	488180xyz7
200	250	488200xyz7
250	300	488250xyz7
300	350	488300xyz7
350	400	488350xyz7
400	450	488400xyz7

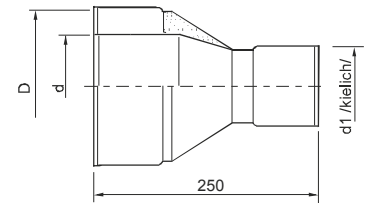

xyz /d1/ - średnica zgodnie z zamówieniem

ELEMENT NIETYPOWY

999

Elementy niekatalogowe wykonywane są na podstawie rysunków dostarczonych przez klienta. Wycena takich elementów jest oparta na indywidualnej kalkulacji.